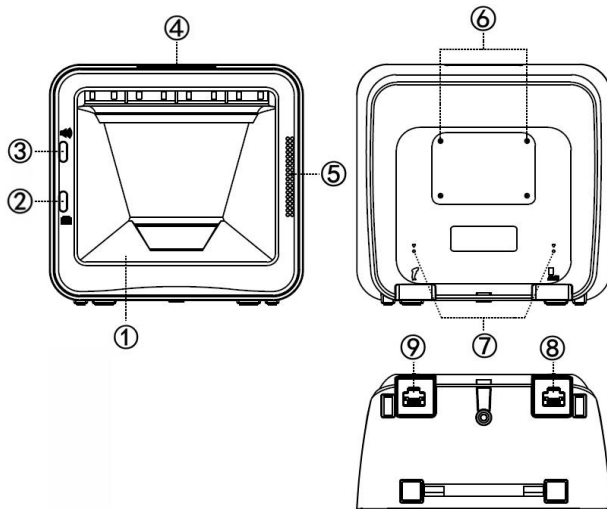

Image Platform Quick Guide

Notice

- A standard packing includes an image platform, a USB cable and a quick guide.
- Accessories include a stand, a RS232 cable.
- Use a piece of dry and soft cloth when cleaning the image platform is in need.

Parts of the scanner



- ① Exit window
- ② Camera push button
- ③ Beeper push button
- ④ LED
- ⑤ Beeper
- ⑥ Hanging holes
- ⑦ Release-hole of the cable
- ⑧ Host interface
- ⑨ Auxiliary interface for handheld scanner, etc.

Installation of cradle

1. Refer to the below pictures, connect the host with the platform based on different cables;
2. Ensure that all connections are secure.
3. If the installation is successful, the beeper will beep and LED will light.

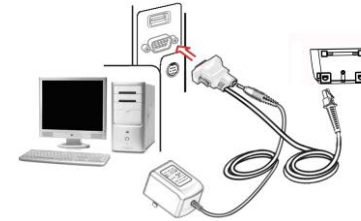

RS232 cable

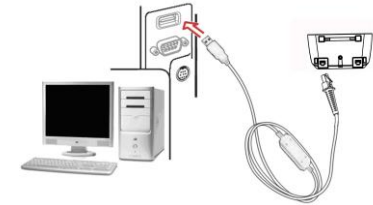

USB cable

Programming instruction and example

Two programming modes have been provided as follows:

- Single-scan setting

Scan the appropriate single-scan setting barcode.

Scan the appropriate

Single-scan setting



%0301D03%

Example: To set Flow control to be XON/XOFF.

- Multiple-scan setting

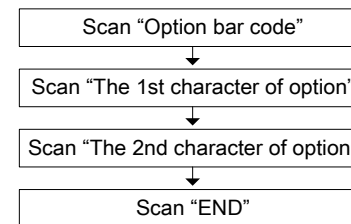

%0301M%



0



3



%END%

Example: To set Flow control to be XON/XOFF.

Reading techniques

1. Move the barcode to close to the image platform.
2. In general, the reading range of the image platform is limited to 2-8cm regardless of the size of the minimal element of the barcode.
3. On a successful reading, the beeper will beep and the LED will light. If no barcode closes to the image platform in a moment, the image platform will go to sleep.

Initialization settings and information display

Default value initialization



Firmware version list



Beeper indication

Disable



%0503D00%

Enable*



%0503D01%

Volume of beeper

Low



%0505D00%

Middle



%0505D01%

High*



%0505D02%

Note: The factory default settings are indicated with asterisks ().*

Assembling the stand



Figure 2-1

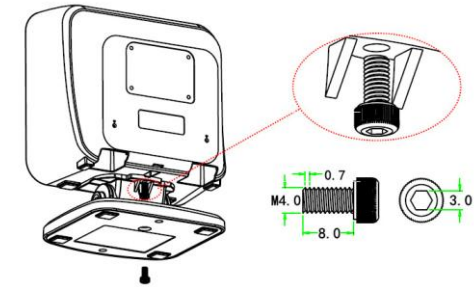

Figure 2-2

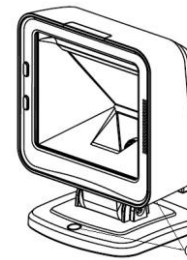

Figure 2-3

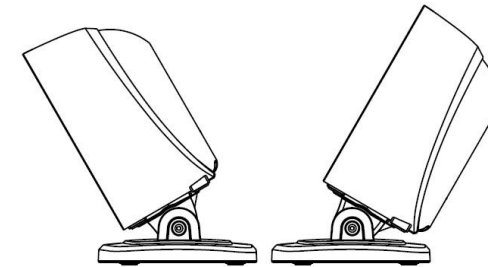

Figure 2-4

1. As shown in Figure 2-1, plug in two connection-arms to the two associated notches on the bottom of the image platform.
2. As shown in Figure 2-2, well connect the image platform with the stand by tightening the single screw.
3. As shown in Figure 2-3, if you want to fix the stand on a table or other platform, you can remove two plastic stopper on the stand (see ①), then fix the stand with a table with appropriate screws.
4. As shown in Figure 2-4, adjust the image platform forward/backward for a desired position.