

CipherLab User Guide

WR30 Wearable Ring Scanner

(Setup barcodes included)

Version 1.04



Copyright © 2023 CIPHERLAB CO., LTD.

All rights reserved

The software contains proprietary information of CIPHERLAB CO., LTD.; it is provided under a license agreement containing restrictions on use and disclosure and is also protected by copyright law. Reverse engineering of the software is prohibited.

Due to continued product development this information may change without notice. The information and intellectual property contained herein is confidential between CIPHERLAB and the client and remains the exclusive property of CIPHERLAB CO., LTD. If you find any problems in the documentation, please report them to us in writing. CIPHERLAB does not warrant that this document is error-free.

No part of this publication may be reproduced, stored in a retrieval system, or transmitted in any form or by any means, electronic, mechanical, photocopying, recording or otherwise without the prior written permission of CIPHERLAB CO., LTD.

For product consultancy and technical support, please contact your local sales representative. Also, you may visit our web site for more information.

The CipherLab logo is a registered trademark of CIPHERLAB CO., LTD.

All brand, product and service, and trademark names are the property of their registered owners.

The editorial use of these names is for identification as well as to the benefit of the owners, with no intention of infringement.

CIPHERLAB CO., LTD.

Website: <http://www.cipherlab.com>

IMPORTANT NOTICES

FOR USA

FEDERAL COMMUNICATIONS COMMISSION INTERFERENCE STATEMENT

This equipment has been tested and found to comply with the limits for a Class B digital device, pursuant to part 15 of the FCC Rules. These limits are designed to provide reasonable protection against harmful interference in a residential installation. This equipment generates, uses and can radiate radio frequency energy and, if not installed and used in accordance with the instructions, may cause harmful interference to radio communications. However, there is no guarantee that interference will not occur in a particular installation. If this equipment does cause harmful interference to radio or television reception, which can be determined by turning the equipment off and on, the user is encouraged to try to correct the interference by one or more of the following measures:

- Reorient or relocate the receiving antenna.
- Increase the separation between the equipment and receiver.
- Connect the equipment into an outlet on a circuit different from that to which the receiver is connected.
- Consult the dealer or an experienced radio/ TV technician for help.

CAUTION:

Any changes or modifications not expressly approved by the grantee of this device could void the user's authority to operate the equipment.

This device complies with Part 15 of the FCC Rules. Operation is subject to the following two conditions: (1) this device may not cause harmful interference, and (2) this device must accept any interference received, including interference that may cause undesired operation.

RF exposure warning

This device contains transmitters and receivers which emit Radio Frequency (RF) energy. The device is designed to comply with the limits for exposure to RF energy set by the Federal Communications Commission (FCC) of the United States, Industry Canada (IC) of Canada, and the regulating entities of other countries

FOR CANADA

Canada, Industry Canada (IC) Notices

This device contains licence-exempt transmitter(s)/receiver(s) that comply with Innovation, Science and Economic Development Canada's licence-exempt RSS(s). Operation is subject to the following two conditions:

(1) This device may not cause interference.

(2) This device must accept any interference, including interference that may cause undesired operation of the device.

Canada, avis d'Industry Canada (IC)

L'émetteur/récepteur exempt de licence contenu dans le présent appareil est conforme aux CNR d'Innovation, Sciences et Développement économique Canada applicables aux appareils radio exempts de licence. L'exploitation est autorisée aux deux conditions suivantes :

- 1. L'appareil ne doit pas produire de brouillage;*

L'appareil doit accepter tout brouillage radioélectrique subi, même si le brouillage est susceptible d'en compromettre le fonctionnement.

Radio Frequency (RF) Exposure Information

The radiated output power of the Wireless Device is below the Industry Canada (IC) radio frequency exposure limits. The Wireless Device should be used in such a manner such that the potential for human contact during normal operation is minimized.

This device has also been evaluated and shown compliant with the IC RF Exposure limits under mobile exposure conditions. (antennas are greater than 20cm from a person's body).

Informations concernant l'exposition aux fréquences radio (RF)

La puissance de sortie émise par l'appareil de sans fil est inférieure à la limite d'exposition aux fréquences radio d'Industry Canada (IC). Utilisez l'appareil de sans fil de façon à minimiser les contacts humains lors du fonctionnement normal.

Ce périphérique a également été évalué et démontré conforme aux limites d'exposition aux RF d'IC dans des conditions d'exposition à des appareils mobiles (antennes sont supérieures à 20 cm à partir du corps d'une personne).

FOR HAND-HELD PRODUCT WITH RF FUNCTIONS

The WR30 unit (FCC ID: Q3N-WR30) complies with FCC radiation exposure limits set forth for uncontrolled environment and meets the FCC radio frequency (RF) Exposure Guidelines in Supplement C to OET65. The unit has very low level of RF energy that it is deemed to comply without testing of specific absorption ratio (SAR).

FOR PRODUCT WITH LASER

CAUTION

This laser component



emits FDA / IEC Class 2 laser light at the exit port. Do not stare into beam.

SAFETY PRECAUTIONS

RISK OF EXPLOSION IF BATTERY IS REPLACED BY AN INCORRECT TYPE. DISPOSE OF USED BATTERIES ACCORDING TO THE INSTRUCTIONS.

- ▶ The use of any batteries or charging devices, which are not originally sold or manufactured by CipherLab, will void your warranty and may cause damage to human body or the product itself.
- ▶ DO NOT disassemble, incinerate or short circuit the battery.
- ▶ DO NOT expose the scanner or the battery to any flammable sources.
- ▶ For green-environment issue, it's important that batteries should be recycled in a proper way.
- ▶ Under no circumstances, internal components are self-serviceable.
- ▶ The charging device uses an AC power adaptor. A socket outlet shall be installed near the equipment and shall be easily accessible. Make sure there is stable power supply for the scanner or its peripherals to operate properly.

CARE & MAINTENANCE

- ▶ Use a clean cloth to wipe dust off the scanning window and the body of the scanner as well as the charging device. DO NOT use/mix any bleach or cleaner.
- ▶ If you want to put away the scanner for a period of time, download the collected data to a host computer when in the memory mode, and then take out the battery. Store the scanner and battery separately.
- ▶ When the scanner resumes its work, make sure the battery is fully charged before use.
- ▶ If you shall find the scanner malfunctioning, write down the specific scenario and consult your local sales representative.

RELEASE NOTES

Version	Date	Notes
1.04	Oct. 31, 2023	<ul style="list-style-type: none">▶ Add the description related to the disconnection after restoring system defaults in Section 3.2.2
1.03	Oct. 19, 2023	<ul style="list-style-type: none">▶ Modify the LED description about the charging status in Section 1.3 and other related sections
1.02	Sep. 04, 2023	<ul style="list-style-type: none">▶ Add Section 2.5 "RS-232 VIA WR30 Dongle(RS232)"▶ Modify the description of examples in Section 5.2.2▶ Modify Section 3.5.1"Connect to WR30 Dongle"▶ Add Section 3.6 "Connect to PC via WR30 Dongle(RS232)"▶ Add the description related to device name in Section 3.2.2▶ Add the description related to iOS in Section 2.6.5▶ Add "WR30 Dongle Setup Barcodes & Serial Commands" in Appendix II
1.01	July 28, 2023	<ul style="list-style-type: none">▶ Section 3.5.2: Modify the picture▶ Modify the barcodes placed on the footer▶ Modify the content at the beginning of the chapter
1.00	July 25, 2023	<ul style="list-style-type: none">▶ Initial release

CONTENTS

IMPORTANT NOTICES	- 4 -
For USA.....	- 4 -
For Canada.....	- 5 -
For Hand-held Product with RF Functions.....	- 6 -
For Product with Laser.....	- 6 -
Safety Precautions	- 6 -
Care & Maintenance.....	- 6 -
RELEASE NOTES	- 7 -
CONTENTS	I
INTRODUCTION	1
Getting Familiarized with the Scanner	2
Overview of the Scanner	2
Installing the Battery to the Scanner	3
Charging the Battery via the USB Cable (For Detachable Trigger)	4
Charging the Battery via the USB TYPE-C Charger.....	5
Charging the Battery via 8-Slot Battery Charger	6
Inside the Package.....	7
Product Highlights	7
Symbologies Supported	9
QUICK START	11
Enter Configuration Mode.....	14
Exit Configuration Mode.....	14
Default Settings	14
Save User Settings as Defaults.....	14
Restore User Defaults.....	15
Restore System Defaults.....	15
Read a Setup Barcode	15
Configure Parameters.....	15
List the Current Settings	20
Create One-Scan Setup Barcodes.....	23
1D One-Scan Barcode	23
Setup QR Code.....	24
CHAPTER 1. UNDERSTANDING THE RING SCANNER	25
1.1 Battery	26
1.1.1 Turn on/off the Scanner	26

1.1.2 Power Economy	27
1.1.3 Power Economy vs. WPAN Connection	30
1.2 Memory.....	31
1.2.1 Transmit Buffer	31
1.2.2 Memory Mode.....	32
1.2.3 Free Memory	33
1.2.4 Record Count of Memory	33
1.3 LED Indicator.....	34
1.3.1 Good Read LED.....	35
1.3.2 Good Read LED Duration	35
1.4 Beeper.....	36
1.4.1 Beeper Volume	37
1.4.2 Good Read Beep	37
1.4.3 Low Battery Alarm	38
1.4.4 Bell Ring	38
1.4.5 Power-on Beep	39
1.5 Send "NR" to Host.....	39
1.6 Scan Modes.....	39
1.6.1 Test Mode	41
1.6.2 Laser Mode.....	41
1.6.3 Auto Off Mode.....	41
1.6.4 Auto Power Off Mode	42
1.6.5 Aiming Mode.....	42
1.6.6 Multi-Barcode Mode.....	43
1.6.7 Release Mode	43
1.7 Scanning Timeout.....	44
1.8 Delay between Re-read.....	45
1.9 Read Redundancy (1D)	46
1.10 Addon Security for UPC/EAN Barcodes.....	46
1.11 Negative Barcodes.....	47
1.12 Picklist Mode	47
1.13 Mobile Phone/Display Mode	47
1.14 Illumination Brightness.....	48
1.15 Serial Number Stamp	48
1.15.1 Separator between Serial Number Stamp and Data.....	48
1.16 2D Decode Settings.....	49
1.16.1 Aiming Pattern	49
1.16.2 Decoding Illumination	49
1.17 Vibrator Setup.....	49
CHAPTER 2. SELECTING OUTPUT INTERFACE.....	51
2.1 BT HID	52
2.1.1 Activate BT HID & Select Keyboard Type	53
2.1.2 Reset Connection.....	54
2.1.3 Keyboard Settings.....	54

2.1.4 Inter-Character Delay.....	60
2.1.5 Inter-Function Delay	60
2.1.6 HID Character Transmit Mode.....	61
2.1.7 Special Keyboard Feature	61
2.1.8 Keypad Support for iPhone/iPad.....	62
2.1.9 Transmit Speed	62
2.1.10 UTF-8 Conversion	63
2.2 BLE SPP LITE	63
2.2.1 Activate BLE SPP LITE MODE.....	63
2.2.2 Inter-Function Delay	64
2.2.3 ACK/NAK Timeout	64
2.2.4 BLE SPP LITE Hardware Flow Control.....	65
2.3 DIRECT USB VCOM CDC	65
2.3.1 Activate USB VCOM CDC	65
2.3.2 Inter-Function Delay	65
2.3.3 ACK/NAK Timeout	66
2.4 Direct USB HID.....	67
2.4.1 Activate USB HID & Select Keyboard Type	67
2.4.2 Keyboard Settings.....	69
2.4.3 Inter-Character Delay.....	75
2.4.4 Inter-Function Delay	75
2.4.5 HID Character Transmission Mode	75
2.4.6 Special Keyboard	76
2.4.7 UTF-8 Conversion.....	76
2.5 RS-232 via WR30 Dongle.....	77
2.5.1 Activate RS-232 Interface.....	77
2.5.2 Baud Rate.....	77
2.5.3 Parity	78
2.5.4 Inter-Function Delay	78
2.5.5 ACK/NAK Timeout	79
2.6 Connect USB HID via WR30 Dongle.....	80
2.6.1 Activate USB HID & Select Keyboard Type	81
2.6.2 Keyboard Settings.....	82
2.6.3 Inter-Character Delay.....	88
2.6.4 Inter-Function Delay	88
2.6.5 HID Character Transmit Mode.....	88
2.6.6 Special Keyboard Feature	89
2.6.7 USB HID via WR30 Dongle Auto-reconnection	89
2.6.8 UTF-8 Conversion.....	89
2.7 Connect USB VCOM_CDC via WR30 Dongle	90
2.7.1 Activate USB VCOM_CDC	90
2.7.2 Inter-Function Delay	90
2.7.3 ACK/NAK Timeout	90
2.7.4 USB VCOM_CDC via WR30 Dongle Auto-Reconnection.....	91
CHAPTER 3. SETTING UP A WPAN CONNECTION.....	92
3.1 Connect to THE HID of Mobile Computer via Bluetooth	94
3.1.1 Change Interface.....	94

3.1.2 Build a Connection with the Mobile Computer via Bluetooth	94
3.2 Connect to BLE SPP LITE of the Mobile Computer via Bluetooth.....	97
3.2.1 Change Interface	97
3.2.2 Scan QR Code to Connect with A Mobile Computer via Bluetooth.....	97
3.2.3 Build A Bluetooth Connection with the Mobile Computer through NFC	99
3.3 Connect to BT HID of PC via Bluetooth Dongle	100
3.3.1 Change Interface	100
3.3.2 Build a Connection using Bluetooth Dongle	101
3.4 Enter PIN Code for Authentication.....	104
3.4.1 Use Just Works.....	104
3.4.2 Use Preset PIN.....	104
3.4.3 Use Random PIN.....	105
3.4.4 Use OOB (Out Of Bank) through NFC.....	105
3.5 Connect to PC via WR30 Dongle.....	106
3.5.1 Connect to WR30 Dongle	106
3.5.2 Change WR30 Dongle Interface.....	107
3.6 Connect to PC via WR30 Dongle(RS232).....	108
3.6.1 Connect to WR30 Dongle (RS232)	108
CHAPTER 4. CHANGING SYMBOLOGY SETTINGS	109
4.1 Codabar	110
4.1.1 Start/Stop Transmission	110
4.1.2 CLSI Conversion.....	110
4.1.3 Code Length Qualification	110
4.2 Code 25 – Industrial 25	112
4.2.1 Code Length Qualification	112
4.3 Code 25 – Interleaved 25.....	113
4.3.1 Verify Check Digit.....	113
4.3.2 Transmit Check Digit.....	113
4.3.3 Convert to EAN-13	113
4.3.4 Code Length Qualification	114
4.4 Code 25 – Matrix 25.....	115
4.4.1 Verify Check Digit.....	115
4.4.2 Transmit Check Digit.....	115
4.4.3 Code Length Qualification	115
4.5 Code 25 – Chinese 25.....	117
4.6 Italian Pharmacode (Code 32)	117
4.7 Code 39	117
4.7.1 Verify Check Digit.....	117
4.7.2 Transmit Check Digit.....	118
4.7.3 Standard/Full ASCII Code 39.....	118
4.7.4 Code Length Qualification	119
4.8 Trioptic Code 39	120
4.9 Code 93	120
4.9.1 Code Length Qualification	120

4.10 Code 128.....	122
4.11 GS1-128 (EAN-128).....	122
4.11.1 Transmit Code ID.....	122
4.11.2 Field Separator (GS Character).....	122
4.11.3 GS1 Formatting	123
4.12 ISBT 128.....	124
4.12.1 ISBT Concatenation	124
4.12.2 ISBT Concatenation Redundancy.....	125
4.13 GS1 DataBar (RSS Family)	126
4.13.1 Select Code ID	126
4.13.2 GS1 DataBar Omnidirectional (RSS-14).....	126
4.13.3 GS1 DataBar Expanded (RSS Expanded).....	128
4.13.4 GS1 DataBar Limited (RSS Limited).....	128
4.13.5 Convert to UPC/EAN	130
4.13.6 Field Separator (GS Character).....	130
4.13.7 Application ID Mark.....	131
4.14 MSI	132
4.14.1 Verify Check Digit	132
4.14.2 Transmit Check Digit.....	132
4.14.3 Code Length Qualification.....	133
4.15 EAN-8.....	134
4.15.1 Transmit Check Digit.....	134
4.16 EAN-13.....	135
4.16.1 EAN-13 Addon Modes.....	135
4.16.2 Convert to ISBN	138
4.16.3 Convert to ISSN	138
4.16.4 Transmit Check Digit.....	138
4.17 UCC Coupon Extended Code.....	139
4.18 UPC-A.....	139
4.18.1 Convert to EAN-13	140
4.18.2 Transmit System Number.....	140
4.18.3 Transmit Check Digit.....	140
4.19 UPC-E.....	141
4.19.1 Select System Number	141
4.19.2 Convert to UPC-A.....	142
4.19.3 Transmit System Number.....	142
4.19.4 Transmit Check Digit.....	142
4.20 Code 11.....	144
4.20.1 Verify Check Digit	144
4.20.2 Transmit Check Digit.....	144
4.20.3 Code Length Qualification.....	145
4.21 Composite Code.....	146
4.21.1 Composite CC-A/B.....	146
4.21.2 Composite CC-C	146
4.21.3 Composite TLC-39	147
4.21.4 UPC Composite Mode	147

4.21.5 GS1-128 Emulation Mode for UCC/EAN Composite Codes.....	148
4.21.6 Field Separator (GS Character).....	148
4.21.7 Application ID Mark.....	148
4.22 US Postal Code.....	149
4.22.1 US Postnet.....	149
4.22.2 US Planet.....	149
4.22.3 Transmit Check Digit.....	149
4.23 UK Postal Code.....	150
4.23.1 UK Postal.....	150
4.23.2 Transmit Check Digit.....	150
4.24 More Postal Code.....	150
4.24.1 Japan Postal.....	150
4.24.2 Australian Postal.....	151
4.24.3 Dutch Postal.....	151
4.24.4 USPS 4CB/One Code/Intelligent Mail.....	151
4.24.5 UPU FICS Postal.....	151
4.25 2D Symbologies.....	152
4.25.1 PDF417.....	152
4.25.2 MicroPDF417.....	152
4.25.3 Data Matrix.....	152
4.25.4 Maxicode.....	154
4.25.5 QR Code.....	154
4.25.6 MicroQR.....	156
4.25.7 Aztec.....	156
4.26 Macro PDF.....	157
4.26.1 Transmit/Decode Mode.....	157
4.26.2 Escape Characters.....	158
4.26.3 Transmit Control Header.....	158
CHAPTER 5. DEFINING OUTPUT FORMAT	159
5.1 Letter Case.....	160
5.2 Character Substitution.....	160
5.2.1 Single Character Substitution.....	161
5.2.2 Multiple Character Substitution.....	162
5.2.3 Symbologies for Character Substitution (All 3 Sets).....	164
5.3 Prefix/Suffix Code.....	174
5.4 Code ID.....	175
5.4.1 Select Pre-defined Code ID.....	175
5.4.2 Change Code ID.....	178
5.4.3 Clear Code ID Settings.....	181
5.5 Length Code.....	182
5.6 Multi-Barcode Editor.....	190
5.6.1 Edit a Concatenation of Barcodes.....	191
5.6.2 Activate the Concatenation of Barcodes.....	192
5.7 Removal of Special Character.....	193
5.8 AIM Code ID.....	194

CHAPTER 6. APPLYING FORMATS FOR DATA EDITING	195
6.1 Activating Editing Formats.....	196
6.1.1 Activate Editing Formats.....	196
6.1.2 Exclusive Data Editing.....	197
6.2 How to Configure Editing Formats.....	198
6.2.1 Select Format to Configure.....	198
6.2.2 Restore Default Format.....	199
6.3 Configuring Format — Define Data Criteria.....	200
6.3.1 Applicable Code Type.....	200
6.3.2 Data Length.....	210
6.3.3 Matching String & Location.....	210
6.4 Configuring Format — Define Data Field.....	211
6.4.1 Start Position.....	211
6.4.2 Field Adjustment.....	211
6.4.3 Total Number of Fields.....	212
6.4.4 Field Settings.....	213
6.4.5 Pause Field Setting.....	218
6.5 Configuring Format — Define Transmission Sequence.....	219
6.6 Programming Examples.....	221
6.6.1 Example I.....	221
6.6.2 Example II.....	221
SPECIFICATIONS	223
APPENDIX I. FIRMWARE UPGRADE	225
How to Upgrade Scanner Firmware.....	225
Using USB-Type C Cable.....	225
Connect to cipherlab Mobile computer via Bluetooth.....	226
APPENDIX II. HOST SERIAL COMMANDS	227
Serial Commands.....	227
Example.....	230
WR30 USB Dongle Setup Barcodes & Serial Commands.....	231
WR30 USB Dongle Serial Command and Equivalent Setup Barcodes.....	232
Example.....	233
APPENDIX III. KEYBOARD WEDGE TABLE	234
Apply Special Keyboard.....	234
Bypass Special Keyboard.....	235
Bypass Special Keyboard with Control Character Output.....	236
Key Type & Status.....	237
Key Type.....	237
Key Status.....	237
Example.....	238
APPENDIX IV. NUMERAL SYSTEMS	239
Decimal System.....	239

- Hexadecimal System.....240
- ASCII Table.....241
- APPENDIX V. READING DRIVER LICENSES.....242**
 - License Parsing Setup.....242
 - File Type.....242
 - Output Sequence Setup.....243
 - Separators and Fields249
 - Edit Separators.....250
 - Edit Fields251
- APPENDIX VI. KEYBOARD TYPE ONE-SCAN BARCODE.....252**
 - Bluetooth HID252
 - Direct USB HID.....255
 - Remote USB HID (WR30 Dongle)258

INTRODUCTION

CipherLab ring scanners are specifically designed to answer your mobile demands. The versatile scanners are designed to help accelerate productivity while lowering the total cost of ownership. Intensive data collection jobs are made easier with fast, accurate barcode scanning in various working environments, especially in small businesses. Integrating short-distance wireless technology to small-form-factor scanners, the ring scanners are ideal for carrying around, and thus give workers tether-free mobility anytime anywhere and get job done more efficiently. This line of scanners deliver data over a wireless personal network at a range of up to 100 meters and a prolonged battery life to keep business running.

Owing to the slim, ergonomic design, extremely low power consumption, and powerful decoding capability, the ring scanners are the best choice for the following applications –

- ▶ Receiving in Retail
- ▶ Product labeling & Tracking
- ▶ Shelf Product Replenishment
- ▶ Mobile Point of Sale (POS)
- ▶ Mobile Inventory Management
- ▶ Order Picking & Staging
- ▶ Work-In-Process Tracking
- ▶ Material Flow Control
- ▶ Transportation & Distribution
- ▶ Warehousing
- ▶ Asset Management

This manual contains information on operating the scanner and using its features. We recommend that you keep one copy of the manual at hand for quick reference or maintenance purposes. To avoid any improper disposal or operation, please read the manual thoroughly before use.

Thank you for choosing CipherLab products!



GETTING FAMILIARIZED WITH THE SCANNER

OVERVIEW OF THE SCANNER

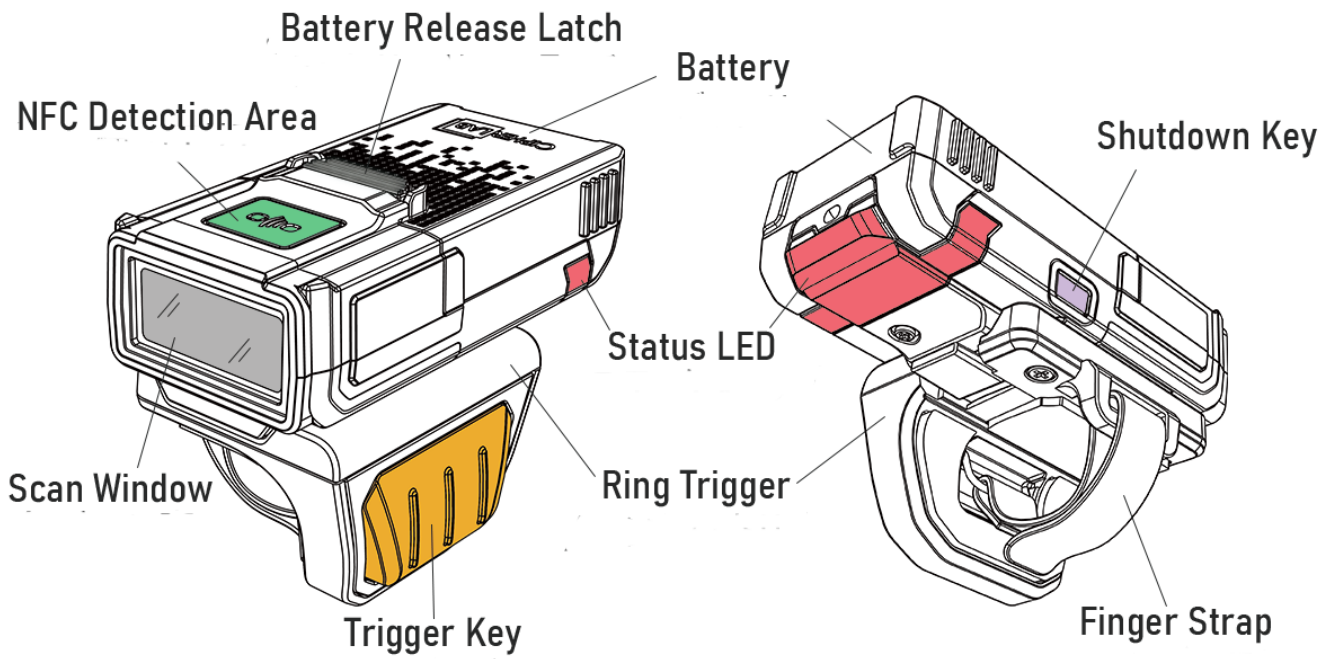

INSTALLING THE BATTERY TO THE SCANNER

When you first receive the package, the rechargeable battery is stored separately from the scanner. Install the battery onto the scanner first so that it can be charged when connecting the ring scanner and PC with a USB Type C cable.

Note: Any improper handling may reduce the battery life span.

- 1) Hold the ring scanner and gently push the battery into the locking slot of the scanner by aiming the contact pins of the battery at the contact pins of the ring scanner..
- 2) A "Click" sound will be heard to ensure that the battery is secured firmly.
- 3) Hold down the trigger about 3 seconds to turn on the scanner.
- 4) The scanner will respond with a long beep (high tone)and its LED will come on-off shortly.

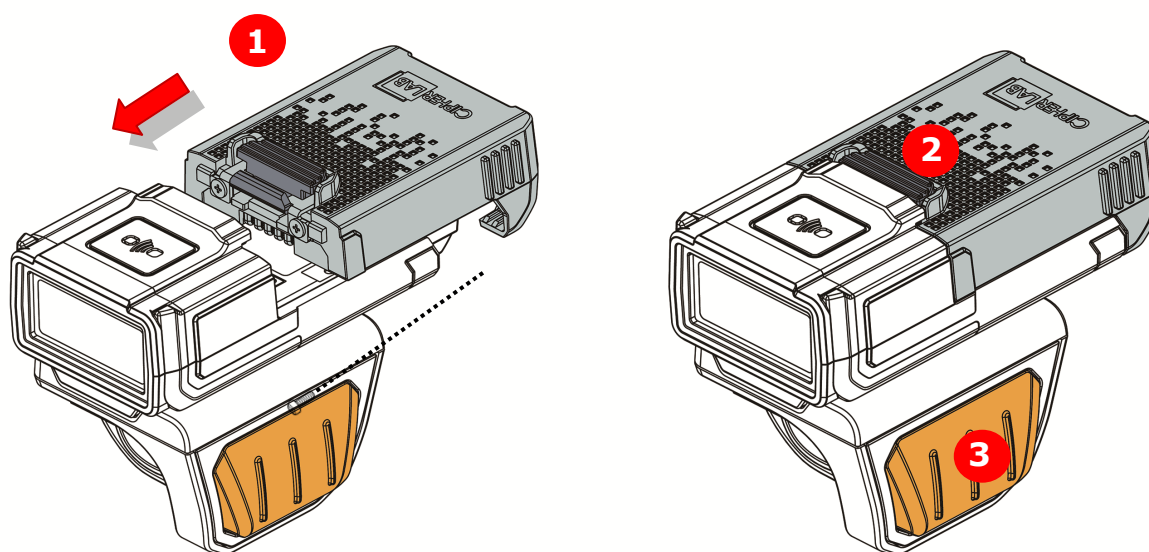

- Note:
- (1) To turn off the scanner, remove the battery.
 - (2) For shipping and storage purposes, save the scanner and the battery separately. This will keep the battery in good condition for future use.
 - (3) When the battery charge becomes low, you will find the scanner cannot emit scan beam and its power-on beep sounds differently.



CHARGING THE BATTERY VIA THE USB CABLE (FOR DETACHABLE TRIGGER)

The battery may not be charged to full for shipment. When you first receive the package, you will need to charge the battery to full before using the scanner. When using the USB cable, it takes approximately 4 hours to charge the battery to full (from the 5V power adaptor).

Note: Battery charging stops when the temperature drops below 0°C or exceeds 40°C. It is recommended to charge the battery at room temperature (18°C to 25°C) for optimal performance.

- 1) Hold the detachable trigger, and buckle its tongue located beneath the trigger button into the groove on top of the scan window (See the places marked in red in Step 1 of the figure below).
- 2) Firmly press this detachable trigger down, and a "Click" sound will be heard to fix it.
- 3) Connect the USB port of the ring scanner to PC or the 5V adaptor for external power using the USB Type C cable.

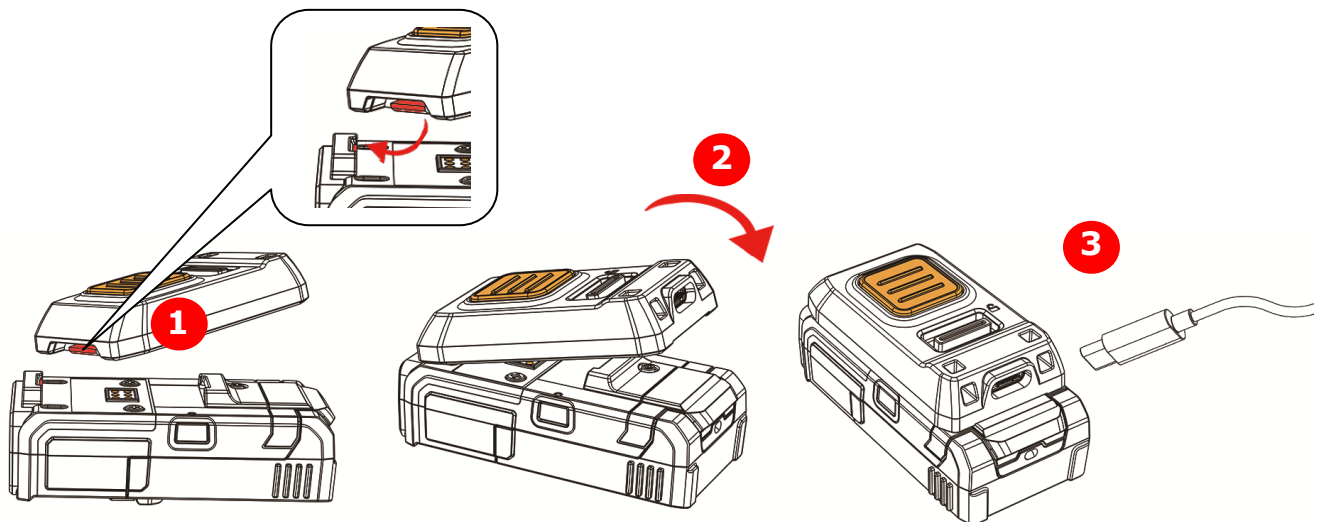

- 4) The scanner LED will become solid red during charging.
- 5) When the charging is done, the red LED will be off. And LED will become solid green.
When the charging error occurs, the LED will flash in red color (On/Off ratio 0.25 s : 0.25 s).

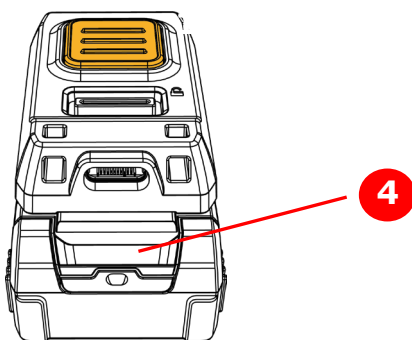

CHARGING THE BATTERY VIA THE USB TYPE-C CHARGER

The battery may not be charged to full for shipment. When you first receive the package, you will need to charge the battery to full before using the scanner. When using the USB cable, it takes approximately 4 hours to charge the battery to full (from the 5V power adaptor).

Note: Battery charging stops when the temperature drops below 0°C or exceeds 40°C. It is recommended to charge the battery at room temperature (18°C to 25°C) for optimal performance.

- 1) Hold the USB TYPE-C charger, and buckle its tongue located beneath the USB-C port into the groove on top of the scan window (See the places marked in red in Step 1 of the figure below).
- 2) Firmly press this USB TYPE-C charger down, and a "Click" sound will be heard to fix it.
- 3) Connect the USB-C port on USB TYPE-C charger to PC or the 5V adaptor for external power using the USB Type C cable.

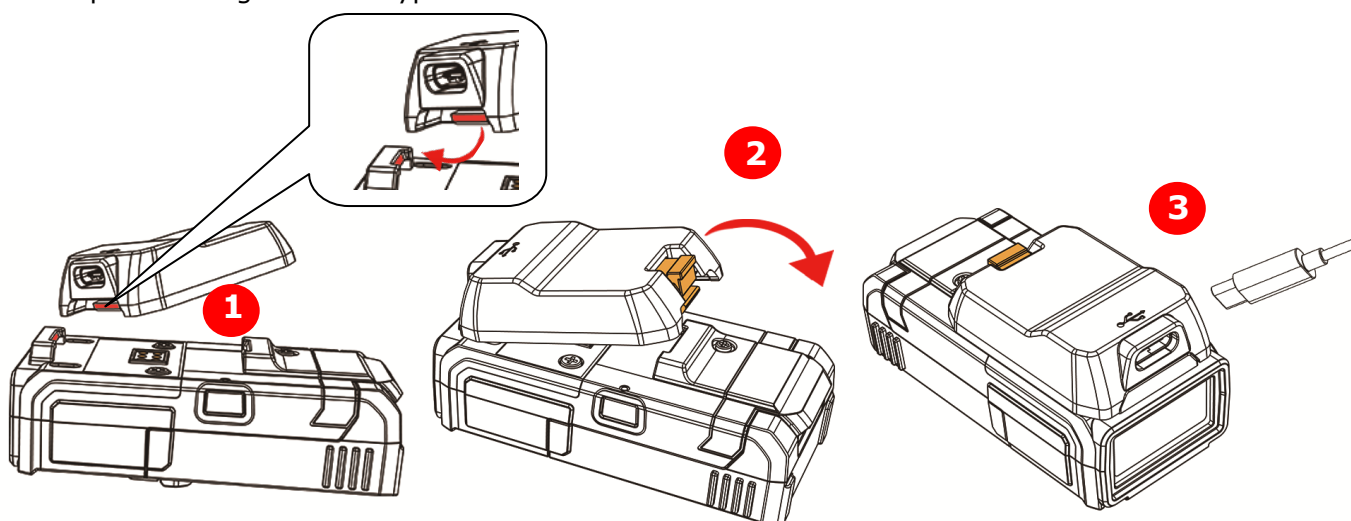

- 4) The scanner LED will become solid red during charging.
 - 5) When the charging is done, the red LED will be off. And LED will become solid green.
- When the charging error occurs, the LED will flash in red color (On/Off ratio 0.25 s : 0.25 s).

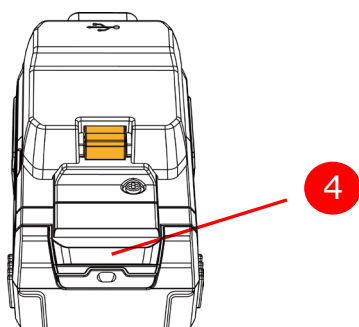

CHARGING THE BATTERY VIA 8-SLOT BATTERY CHARGER

The 8-slot battery charger is optionally provided for charging the battery only. You may purchase the charger separately. It takes within 4 hours to charge the battery to full.

Note: Battery charging stops when the temperature drops below 0°C or exceeds 40°C. It is recommended to charge the battery at room temperature (18°C to 25°C) for optimal performance.

- 1) Connect the DC12 V power supply cord to the power connector of the 8-slot battery charger.
- 2) Connect the other end of this power supply cord to a suitable power outlet.
- 3) Slide the battery smoothly into the slot separately.

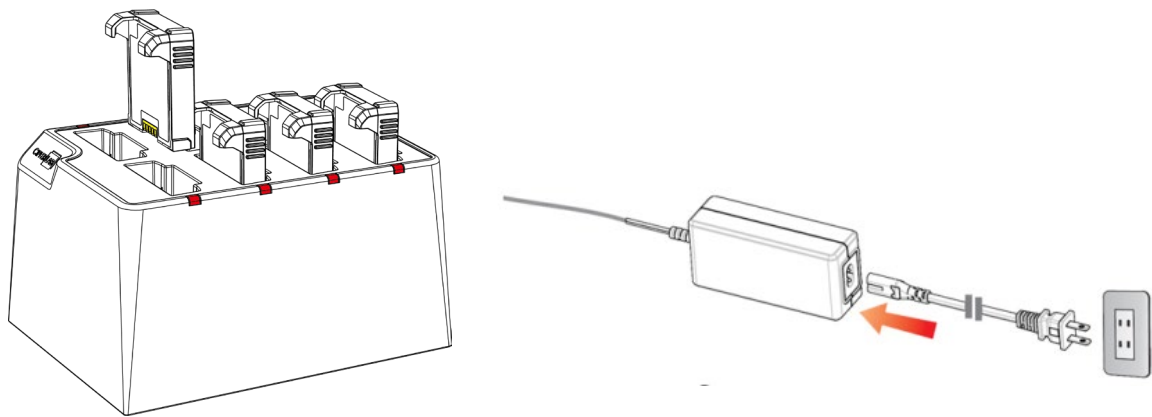

Status LED		Meaning
Red, flashing	Green, flashing	Charger is powered ON (LED flashes once in red and green colors (ratio 0.5 s: 0.5 s) for 1 second by turns).
Red, solid	---	The battery is being charged.
---	Green, solid	Charging is done.
Red, flashing		<p>The LED will flash upon the time interval as follows:</p> <ul style="list-style-type: none"> ■ 1 second: It stands that the temperature is too high or too low (Normal Operation: 0°C ~40°C). ■ 2 seconds: It stands that an error occurs when charging. ■ 3 seconds: It stands that the battery failure or improper contact occurs. ■ 4 seconds: It stands that the battery voltage is too high or too low.



INSIDE THE PACKAGE

The items included in the package may be different, depending on your order. Save the box and packaging material for future use in case you need to store or ship the scanner.

- ▶ WR30 Wearable Ring Scanner (Main core)
- ▶ Ring Trigger (Optional)
- ▶ Ambidextrous Hand Mount Strap with Trigger (Optional)
- ▶ Detachable Trigger (Optional)
- ▶ USB Type-C Charger
- ▶ USB Type-C Cable (Optional)
- ▶ Adapter (Optional)
- ▶ Rechargeable Li-ion battery
- ▶ 8-Slot Battery Charger(Optional)
- ▶ Retractable Lanyard (Optional)
- ▶ Wrist Strip
- ▶ WR30 Dongle (Optional)
- ▶ WR30 Dongle RS232 (Optional)
- ▶ Quick Start Guide

PRODUCT HIGHLIGHTS

- ▶ Small-form-factor and built tough to survive drop test
- ▶ Extremely low power consumption
- ▶ Firmware upgradeable
- ▶ Supports most popular barcode symbologies, including GS1-128 (EAN-128), GS1 DataBar (RSS), etc.
- ▶ Supports negative barcodes
- ▶ Supports a variety of 2D symbologies
- ▶ Supports different scan modes, including Laser Mode, Aiming Mode, and so on
- ▶ Programmable feedback via LED indicator, beeper and vibrator
- ▶ Beeping tone and duration programmable for Good Read
- ▶ With the built-in vibrator that allows the users to know whether the decoding of the scanned barcode succeeds or not by the haptic alert.
- ▶ 4 MB flash memory for Memory Mode operation, storing up to 246,723 scans based on EAN-13 barcodes
- ▶ Provides up to 10 KB SRAM for reserve buffer while getting out of range over a wireless personal area network (WPAN), storing up to 640 scans based on EAN-13 barcodes



- ▶ Support BLE SPP LITE, BLE HID(HOGP) and USB HID three short-distance wireless data transmission interfaces, which is capable of transmitting scanned data to PC or the mobile device with *Bluetooth*[®] wireless technology or USB cable.
- ▶ Programmable parameters, including data output format, editing format, symbologies, etc. can be configured by reading the setup barcodes contained in this manual or via the *ScanMaster* software.



SYMBOLOGIES SUPPORTED

Most of the popular barcode symbologies are supported, as listed below. Each can be individually enabled or disabled. The scanner will automatically discriminate and recognize all the symbologies that are enabled. Refer to [Chapter 4 Changing Symbology Settings](#) for details of each symbology.

Symbologies Supported: Enable/Disable		Default	
Codabar		Enabled	
Code 93		Enabled	
MSI			Disabled
Code 128	Code 128	Enabled	
	GS1-128 (EAN-128)	Enabled	
	ISBT 128	Enabled	
Code 2 of 5	Industrial 25	Enabled	
	Interleaved 25	Enabled	
	Matrix 25		Disabled
	Chinese 25		Disabled
Code 3 of 9	Code 39	Enabled	
	Italian Pharmacode		Disabled
	Trioptic Code 39		Disabled
EAN/UPC	EAN-8	Enabled	
	EAN-8 Addon 2		Disabled
	EAN-8 Addon 5		Disabled
	EAN-13	Enabled	
	EAN-13 & UPC-A Addon 2		Disabled
	EAN-13 & UPC-A Addon 5		Disabled
	ISBN		Disabled
	UPC-E0	Enabled	
	UPC-E1		Disabled
	UPC-E Addon 2		Disabled
	UPC-E Addon 5		Disabled
	UPC-A	Enabled	
	UPC-A Addon 2		Disabled
UPC-A Addon 5		Disabled	



GS1 DataBar (RSS)	GS1 DataBar Omnidirectional (RSS-14)	Enabled	
	GS1 DataBar Truncated	Enabled	
	GS1 DataBar Stacked	Enabled	
	GS1 DataBar Stacked Omnidirectional	Enabled	
	GS1 DataBar Limited (RSS Limited)	Enabled	
	GS1 DataBar Expanded (RSS Expanded)	Enabled	
	GS1 DataBar Expanded Stacked	Enabled	
Code 11			Disabled
Composite Code	Composite CC-A/B		Disabled
	Composite CC-C		Disabled
	Composite TLC-39		Disabled
Postal Code	US Postnet	Enabled	
	US Planet	Enabled	
	UK Postal	Enabled	
	Japan Postal	Enabled	
	Australian Postal	Enabled	
	Dutch Postal	Enabled	
	USPS 4CB/One Code/Intelligent Mail		Disabled
	UPU FICS Postal		Disabled
2D Symbologies	PDF417	Enabled	
	MicroPDF417		Disabled
	Data Matrix	Enabled	
	Maxicode	Enabled	
	QR Code	Enabled	
	MicroQR	Enabled	
	Aztec	Enabled	



QUICK START

The configuration of the scanner can be done by reading the setup barcodes contained in this manual or via the *ScanMaster* software.

This section describes the procedure of configuring the scanner by reading the setup barcodes and provides some examples for demonstration.

Configuration Mode

1. Hold down the trigger about 3 seconds to turn on the scanner. It will respond with a long beep and its LED will come on-off shortly.
2. Have the scanner read the "Enter Setup" barcode. It will respond with six beeps and its LED indicator will become flashing red after reading the barcode.
3. Have the scanner read more setup barcodes... Most of the setup barcodes are normal. The scanner will respond with two beeps (low-high tone). For special setup barcodes, it requires reading more than one setup barcode to complete the setting.
4. Have the scanner read the "Update" or "Abort" barcode. It will respond with six beeps and its LED indicator will become flashing red after reading the barcode.
5. The scanner will restart automatically upon reading the "Update" or "Abort" barcode. It will respond with a long beep and its LED will come on-off shortly.



Note: Refer to [Chapter 2](#) on how to select the output interface.



Working Mode

Upon powering up, the scanner will try to establish a connection with a mobile computer or PC with *Bluetooth*[®] wireless technology. Refer to [Chapter 3 Setting up a WPAN Connection](#) for details. The connection between the scanners and PC or the mobile computer is made easy and reliable.

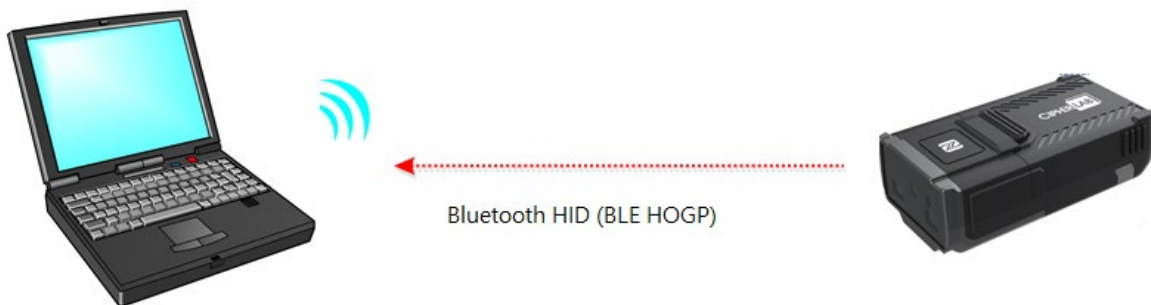
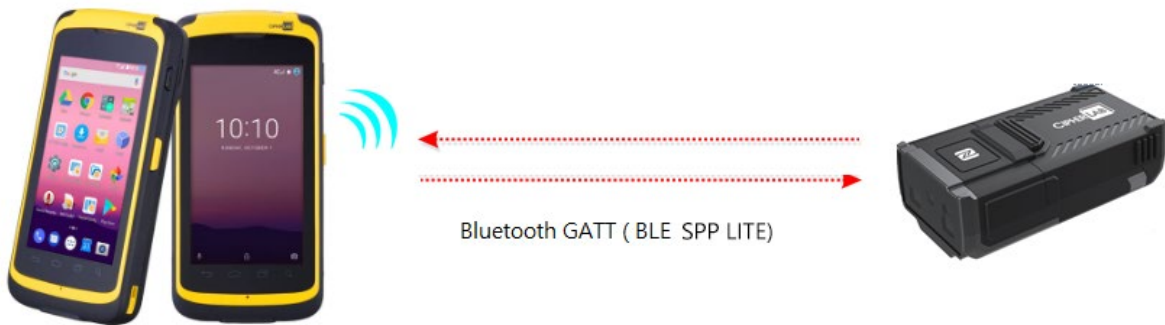

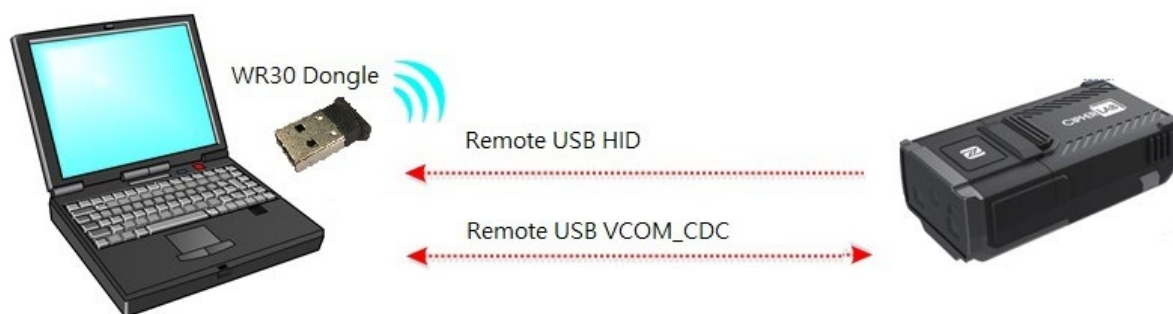

Note: If USB VCOM CDC is selected as the output interface, the host can directly send serial commands to configure the scanner. For example, run HyperTerminal.exe and type the 6-digit command located under each setup barcode. Refer to [Appendix II Host Serial Commands](#).



ENTER CONFIGURATION MODE

For the scanner to enter the configuration mode, you must have it read the "Enter Setup" barcode, which can be located at the bottom of almost every even page of this manual.

- ▶ The scanner will respond with six beeps and its LED indicator will become flashing red after reading the barcode.

Enter Setup



For configuring scanner parameters, see "Read a Setup Barcode" below.

EXIT CONFIGURATION MODE

For the scanner to save settings and exit the configuration mode, you must have it read the "Update" barcode, which can be located at the bottom of almost every odd page of this manual. If you want to exit the configuration mode without saving any changes, have the scanner read the "Abort" barcode instead.

- ▶ Just like reading the "Enter Setup" barcode, the scanner will respond with six beeps and its LED indicator will become flashing red after reading the barcode. Wait for a few seconds for the scanner to restart itself.

Update



Abort



DEFAULT SETTINGS

SAVE USER SETTINGS AS DEFAULTS

For the scanner to keep the customized settings as user defaults, you must have it read the "Save as User Defaults" barcode. This is a normal setup barcode, and the scanner will respond with two beeps (low-high tone).

- ▶ After reading the "Update" barcode, the current settings will be saved as user defaults.

Save as User
Defaults



RESTORE USER DEFAULTS

For the scanner to restore the user defaults, which you have saved earlier, you must have it read the "Restore User Defaults" barcode. This is a normal setup barcode, and the scanner will respond with two beeps (low-high tone).

- ▶ After reading the "Update" barcode, all the parameters of the scanner will return to their customized values.

Restore User
Defaults



109987

RESTORE SYSTEM DEFAULTS

For the scanner to restore the factory defaults, you must have it read the "Restore System Defaults" barcode. This is a normal setup barcode, and the scanner will respond with two beeps (low-high tone).

- ▶ After reading the "Update" barcode, all the parameters of the scanner will return to their default values. The current connection record will be cleared as well.

Restore System
Defaults



109993

Note: The system default value (if there is) for each setting is indicated by an asterisk "*".

READ A SETUP BARCODE

CONFIGURE PARAMETERS

For most of the scanner parameters, only one read is required to set them to new values. The scanner will respond with two beeps (low-high tone) when each parameter is set successfully.

But for a number of special parameters, multiple reads are required to complete the setting. In this case, the scanner will respond with a short beep to indicate it needs to read more setup barcodes. These special parameters may require reading one or more setup barcodes, such as

- ▶ Numeric barcodes, say, for keyboard type, inter-character delay, length qualification
- ▶ Hexadecimal barcodes, say, for character strings as prefix, suffix, etc.
- ▶ When "BT HID" or "USB HID" is configured as the interface, Key Type and Key Status will then become applicable. You may decide whether or not to change key status when "Normal Key" is selected as Key Type.



To complete the configuration of these special parameters, it requires reading the "Validate" barcode, and the scanner will respond with two beeps (low-high tone) to indicate the input values are validated.

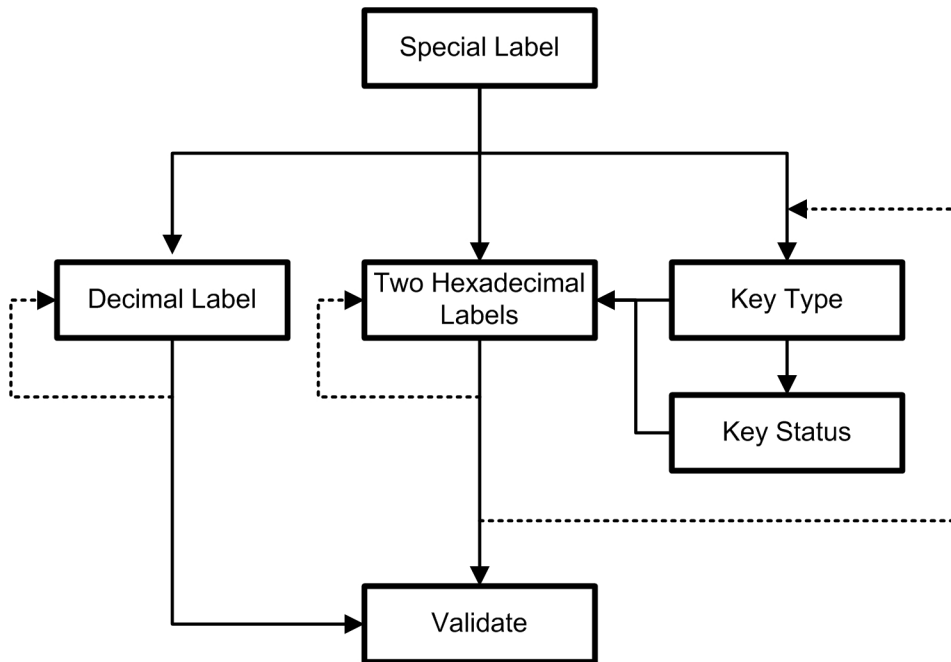

The example below shows how to save your settings as "User Default" so that you may restore user defaults at a later time:

Steps	Action	User Feedback if Successful
1	Power on the scanner...	The scanner will respond with a long beep (high tone) and its LED indicator will become solid red and go off quickly.
2	Enter the Configuration Mode...	The scanner will respond with six beeps (high-low tone repeats three times), and its LED indicator will be flashing red.
3	Read a Setup barcode... For example,	The scanner will respond with two beeps (low-high tone) if reading a normal setup barcode.





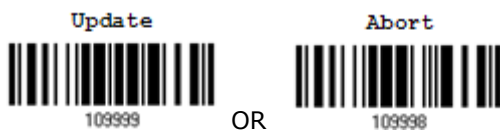





- 4 Exit the Configuration Mode... Same as for *Enter the Configuration Mode*.



- 5 The scanner will automatically restart itself... Same as for *Power on the scanner*.
- * When any configuration error occurs... The scanner will respond with one long beep (low tone).











The example below shows how to set numeric parameters:

Steps	Action	User Feedback if Successful
1	Power on the scanner...	The scanner will respond with a long beep (high tone) and its LED indicator will become solid red and go off quickly.
2	Enter the Configuration Mode... Enter Setup 	The scanner will respond with six beeps (high-low tone repeats three times), and its LED indicator will become flashing red.
3	Read a Setup barcode... For example,	The scanner will respond with two beeps (low-high tone) if reading a normal setup barcode.
	<div style="border: 1px solid red; padding: 2px; display: inline-block;">Normal setup barcode</div> 	
	<div style="border: 1px solid red; padding: 2px; display: inline-block;">Normal setup barcode</div> 	
	<div style="border: 1px solid red; padding: 2px; display: inline-block;">Special setup barcode</div> 	The scanner will respond with one short beep if reading a special setup barcode such as "Max. Length", indicating the setup requires reading more barcodes.
	<div style="border: 1px solid red; padding: 2px; display: inline-block;">Decimal barcodes</div>   	<p>Read the "Decimal Value" barcode(s).</p> <ul style="list-style-type: none"> ▶ Refer to Appendix IV "Decimal System"
4	Exit the Configuration Mode... Update  OR Abort 	Same as for <i>Enter the Configuration Mode</i> .
5	The scanner will automatically restart itself...	Same as for <i>Power on the scanner</i> .



The example below shows how to set string parameters:

Steps	Action	User Feedback if Successful
1	Power on the scanner...	The scanner will respond with a long beep (high tone) and its LED indicator will become solid red and go off quickly.
2	Enter the Configuration Mode... Enter Setup 	The scanner will respond with six beeps (high-low tone repeats three times), and its LED indicator will become flashing red.
3	Read a Setup barcode... For example, Special setup barcodes    Hexadecimal barcodes   	The scanner will respond with one short beep if reading a special setup barcode such as "Prefix Code", indicating the setup requires reading more barcodes. When "BT HID" or "USB HID" is configured as interface, Key Type and Key Status will then become applicable. You may decide whether or not to change key status when "Normal Key" is selected as Key Type. ▶ Refer to Appendix III Read the "Hexadecimal Value" barcodes for the desired character string. For example, read "2" and "B" for the scanner to prefix the character "+". ▶ Refer to Appendix IV "Hexadecimal System"
4	Exit the Configuration Mode... Update  109999 OR Abort  109998	The scanner will respond with two beeps (low-high tone) when the input values are validated. Same as for <i>Enter the Configuration Mode</i> .
5	The scanner will automatically restart itself...	Same as for <i>Power on the scanner</i> .



Update

LIST THE CURRENT SETTINGS

The current settings of all scanner parameters can be sent to the host computer for user inspection. The listing includes pages as shown below. You can select the page of interest by having the scanner read the "List Page x" barcode. The scanner will respond with two beeps (low-high tone) and send the selected page to the host immediately.

List settings regarding Firmware Version, Serial Number, Interface, Buzzer, and Other Scanner Parameters

List Page 1



List settings regarding Prefix, Suffix, and Length Code Setting (1/2)

List Page 2



List settings regarding Prefix, Suffix, and Length Code Setting (2/2)

List Page 3



List settings regarding Code ID

List Page 4



List settings regarding: Readable Symbologies (1/2)

List Page 5



List settings regarding: Readable Symbologies (2/2)

List Page 6



List settings regarding Symbology Parameters (1/3)

List Page 7



List settings regarding Symbology Parameters (2/3)

List Page 8



List settings regarding Symbology Parameters (3/3)

List Page 9



List settings regarding Illumination Brightness	List Page 10	 109959
List settings regarding Editing Format 1 (1/2)	List Page 11	 109937
List settings regarding Editing Format 1 (2/2)	List Page 12	 109938
List settings regarding Editing Format 2 (1/2)	List Page 13	 109939
List settings regarding Editing Format 2 (2/2)	List Page 14	 109940
List settings regarding Editing Format 3 (1/2)	List Page 15	 109941
List settings regarding Editing Format 3 (2/2)	List Page 16	 109942
List settings regarding Editing Format 4 (1/2)	List Page 17	 109943
List settings regarding Editing Format 4 (2/2)	List Page 18	 109944
List settings regarding Editing Format 5 (1/2)	List Page 19	 109945
List settings regarding Editing Format 5 (2/2)	List Page 20	 109946



Lists settings of Driver License parsing

List Page 22



109948



CREATE ONE-SCAN SETUP BARCODES

The fact is most of the scanner parameters require only one read for setting new values. To facilitate configuring the scanner, you may create One-Scan setup barcodes for use.

1D ONE-SCAN BARCODE

The requirements of a One-Scan setup barcode are:

- ▶ a prefix of the "#@" characters
- ▶ the six digits of command parameters
- ▶ a suffix of the "#" character

1) For example, the scanner needs reading three setup barcodes for the command parameter "109952" to take effect:

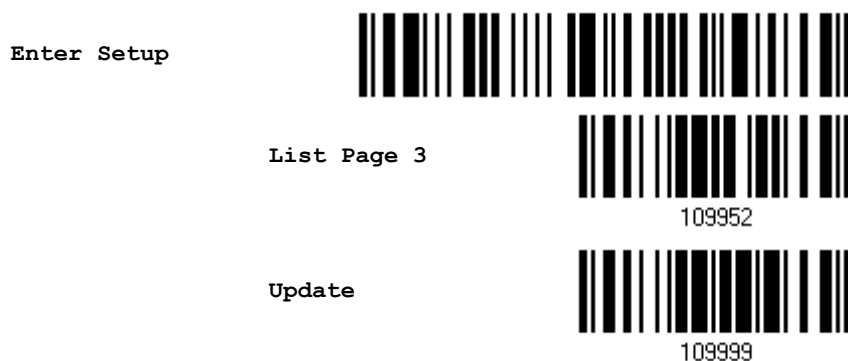

2) Now, it requires only one read:



Note: The scanner will restart automatically upon reading the One-Scan setup barcode for (1) changing the interface or (2) setting memory mode, enable or disable. It will respond with a long beep and its LED will come on-off shortly.



SETUP QR CODE

Users can also scan a single QR code combining with a series of serial commands to configure the scanner. For example, if you want to change the suffix character to `#`, you will need to input the serial commands in sequence as follows (underlining the digits is to make them more readable):

#@CipherLab101231109902109903109994

Command	Purpose
#@CipherLab	Enter Setup
101231	▶ Configure suffix
109902	Give the first hexadecimal digit of 0x23
109903	▶ Give the second hexadecimal digit of 0x23 for taking `#` as the suffix
109994	Validate the settings

The serial commands above can be combined to form a setup QR barcode:

Setup QR Code for configuring suffix



UNDERSTANDING THE RING SCANNER

This chapter explains the features and usage of the ring scanner.

IN THIS CHAPTER

1.1 Battery	26
1.2 Memory	31
1.3 LED Indicator	34
1.4 Beeper.....	36
1.5 Send "NR" to Host.....	39
1.6 Scan Modes.....	39
1.7 Scanning Timeout	44
1.8 Delay between Re-read.....	45
1.9 Read Redundancy (1D).....	46
1.10 Addon Security for UPC/EAN Barcodes	46
1.11 Negative Barcodes.....	47
1.12 Picklist Mode.....	47
1.13 Mobile Phone/Display Mode	47
1.14 Illumination Brightness	48
1.15 Serial Number Stamp	48
1.16 2D Decode Settings	49
1.17 Vibrator Setup	49



1.1 BATTERY

The scanner is powered by a rechargeable 3.85 V/600 mAh Li-ion battery, and it takes approximately 5 hours to charge the battery to full (from the power adaptor). However, the charging time may vary by working condition. For intensive data collection, you may need a spare battery for uninterrupted operation.

Note: The scanner supports power economy. Refer to settings of "[Power Economy](#)" as well as "[Low Battery Alarm](#)".

1.1.1 TURN ON/OFF THE SCANNER

TURN ON

Turn on the scanner

After installing the battery, pull down the trigger for about 3 seconds. The scanner will respond with a long beep (high tone), then the LED will become solid red and go off quickly.

TURN OFF

Turn off the scanner (automatic)

Let the scanner turn off automatically according to the following section [1.1.2.2 Auto Power Off](#) settings.

Turn off the scanner (by pressing the shutdown key)

Press down the shutdown key of the scanner for 15 seconds to turn off the scanner forcibly.

Turn off the scanner (by removing the battery)

Remove the battery directly or let it turn off automatically in specific circumstances.

Turn off the scanner (by pressing the trigger)

Or you can press down the scanner trigger for a specified time to turn off the scanner. Please enable this function and specify the time.

*Enable



Disable



By default, the scanner is turned off after you press the trigger for 5 seconds. Have the scanner to read one of the barcodes below to specify the time.

Pull down trigger for 20 seconds



Pull down trigger for 15 seconds



Pull down trigger for 10 seconds



*Pull down trigger for 5 seconds



Turn off the scanner (by scanning the barcode)

Scan the barcode below to turn off the scanner immediately.

Power Off



1.1.2 POWER ECONOMY

The scanner features "Power-Saving", "Auto Power Off" and "Auto Power Off Ignoring Scan Mode" giving consideration to the power issue that is generally critical for Bluetooth-enabled devices. By the scanner's support of power economy, its power consumption may progress by the following transition:

- 1) running at full CPU speed at power-on
- 2) shifting to low CPU speed (Power-Saving)
- 3) finally shutting down automatically (Auto Power Off)



In the following content of this section, you will be guided through the configurations for the scanner's power economy.

1.1.2.1 POWER-SAVING

For the scanner to save power, you need to appoint the timing for the scanner to shift to power-saving mode. Make the configuration that best suits your application while noting the following points:

- ▶ Power-Saving: 1~254 minutes configurable. 0= Disable.
- ▶ By default, the scanner stands by at full-speed for 2 minutes after power-on and before entering low-speed mode. If Power-Saving isn't desired, set it to 0 to disable it. Read the setup barcode in the following to achieve the setup.

Note: Power-Saving setting won't take effect when the WPAN connection is established successfully via BT HID.

Power-Saving
after
0~254 min. (*2)



- 1) Read the barcode above to enable the scanner to enter low-speed "Power-Saving".
- 2) Assign the time for the scanner to enter low-speed mode by reading the "Decimal Value" barcode on Appendix IV. For example, read "5" for the scanner to enter low-speed mode after idleness of 5 minutes.
- 3) Read the "Validate" barcode on Appendix IV to complete this setting.

Note: Power-Saving won't take effect when one of the following conditions is met:

- (1) the scanner has already established a BT HID connection,
 - (2) the scanner is in the configuration mode,
 - (3) the scan mode is set to Test Mode,
 - (4) the setting value of Power-Saving is greater than that of Auto Power Off,
 - (5) the scanner is plugged into the USB cable and is at the charging status.
-

1.1.2.2 AUTO POWER OFF

For the scanner to save power, further to setting up "Power-Saving" mode, you may also need to enable "Auto Power Off", which deals with a time for the scanner to automatically power off after power-on. Make the configuration that best suits your application while noting the following points:

- ▶ Auto Power Off: 1~254 minutes configurable. 0= Disable.
 1. By default, the scanner automatically shuts down 10 minutes after power-on.
 2. If Auto Power Off isn't desired, set the parameter to 0 to disable it.
 3. When the scan mode is set to Test Mode, you need to enable "Auto Power Off Ignoring Scan Mode" in addition to enabling "Auto Power Off". See the following section [1.1.2.3 Auto Power Off Ignoring Scan Mode](#).



Note 1: When the scanner is set to any scan mode other than Test Mode, you can ignore "Auto Power Off Ignoring Scan Mode".

Note 2 : Auto Power Off does not work while the USB cable is plugged into scanner and in the state of charging .

Auto Power Off
after
0~254 min. (*10)



- 1) Read the barcode above to enable the scanner to automatically turn off at a specified time after power-on.
- 2) Assign the auto power off time by reading the "Decimal Value" barcode on Appendix IV. For example, read "1" and "5" for the scanner to automatically turn off after idleness of 15 minutes.
- 3) Read the "Validate" barcode on Appendix IV to complete this setting.

Note: "Auto Power Off" will not take effect when the scanner is in the configuration mode.

1.1.2.3 AUTO POWER OFF IGNORING SCAN MODE

This mode is intended only for Test Mode. To force a scanner that is set to Test Mode to automatically power off to save power, you need the following settings:

- 1) Enable "Auto Power Off" and set a time for the scanner to automatically power off after power-on. See the foregoing section [1.1.2.2 Auto Power Off](#)
- 2) Enable "Auto Power Off Ignoring Scan Mode" by reading the barcode below:

Enable



*Disable



Read the barcode above to enable/disable automatic power-off for Test Mode.

Note: "Auto Power Off Ignoring Scan Mode" only features enabling and disabling. It doesn't feature the setting of auto power-off time. Such setting should be configured in the preceding setup of "Auto Power Off".



1.1.3 POWER ECONOMY VS. WPAN CONNECTION

Before the scanner can communicate with the host computer, WPAN connection (or Bluetooth connection) needs to be established. The scanner's power economy always accommodates itself to the establishment of the WPAN connection.

The following describes how the scanner carries out power economy before and after the establishment of the WPAN connection:

Before establishing a WPAN connection successfully...

1. The scanner stays active for a specified period of time (2 minutes by default) for the following scenarios. The CPU runs at full speed, and the LED blinks blue (On/Off ratio 0.5 s: 0.5 s).
 - (a) waiting for a connection request from the host (BT HID)
 - (b) trying to connect to the host (BT HID)
2. If the scanner fails to connect within 2 minutes, it becomes inactive to save power for the remaining period of time (the specified "Auto Power Off" value minus 2 minutes). The CPU starts to run at low speed, and the LED begins to slowly blink red (On/Off ratio 0.3 s: 2.5 s).

Pull the trigger to wake up the scanner when it becomes inactive, and the scanner will become active again.
3. If it fails to connect again and again, and finally stays inactive until the specified Auto Power Off time elapses, the scanner will automatically turn off in order to conserve battery power.

Pull down the trigger for about 3 seconds to turn it on again.

Note: For scenarios (a) and (b) in step 1, you may need to search for the scanner again on your computer.

After establishing a WPAN connection successfully...

1. Once a WPAN connection is established successfully, the scanner will stay active for a specified period of time (2 minutes by default) for data transmission. The CPU runs at full speed, and the LED blinks blue (On/Off ratio 0.02 s: 3 s).
2. If the scanner stays idle for 2 minutes (default), it will then turn inactive to save power for the remaining period of time (the specified "Auto Power Off" value minus 2 minutes). The CPU runs at low speed, and the LED is slowly blinking red (On/Off ratio 0.3 s: 2.5 s).

Pull the trigger to wake up the scanner when it becomes inactive, then the scanner will stay active again.

 - ▶ For BT HID, the scanner automatically shuts down.
3. If the scanner first becomes idle and finally stays inactive until the specified Auto Power Off time is up, the scanner will automatically turn off in order to conserve battery power. You will hear three short beeps, tone descending from high to low.

Pull down the trigger for about 3 seconds to turn it on again.

 - ▶ For BT HID, the scanner resumes the connection with the host upon powering on again, as long as the host application is running. You will hear three short beeps, tone ascending from low to high upon the resumption. If the scanner fails to resume the connection, it will try every 5 seconds to re-connect to the host unless you have the scanner read the "Reset Connection" barcode.



1.2 MEMORY

The collected data can be sent back to a host computer one by one via the WPAN connection or stored in flash memory when the scanner is set to Memory mode.

1.2.1 TRANSMIT BUFFER

By default, transmit buffer is enabled and for use when the scanner is out of range. Upon reading a barcode successfully within range, the scanner responds with one short beep (high tone) and its LED indicator becomes solid green and goes off quickly. However, the host computer may not receive the data immediately if getting out of range. With the 10 KB transmit buffer, the scanner can ignore the transmission status and keep on reading barcodes until the buffer is full.

When transmit buffer is enabled...

If the scanner is out of range, it will respond with two short beeps, high-low tone, upon reading a barcode successfully.

When transmit buffer is full, the scanner will respond with one long beep (low tone) and its LED indicator will become solid red and go off quickly. You are advised to get back to range.

When transmit buffer is disabled...

If the scanner is out of range, it will respond with one long beep (low tone) and its LED indicator will become solid red and go off quickly. You are advised to get back to range.

***Enable**



Disable



Note: The 10 KB transmit buffer on the scanner can hold as many as 640 scans based on EAN-13 barcodes. Data will be cleared out once the scanner is turned off or running out of battery power!

CONTINUOUS DECODING

The scanner only proceeds with the next decode after the host computer has successfully received data. In case of transmitting a huge mass of 2D barcode data, users may encounter difficulties in keeping decoding barcodes. Enabling this function can have the scanner keep decoding without waiting for the host to complete the data receiving.

***Enable**



Disable



100110

1.2.2 MEMORY MODE

The scanner keeps 4 MB flash memory for memory mode operation. When the scanner is in memory mode, it means any real-time connection established with host is disabled.

Enable



100237

*Disable



100236

Warning: No real-time connection is allowed unless the memory mode is disabled.

Memory Data Delay

You may set a delay between each data record while transmitting data back to the host.

*None



100238

250 ms



100239

500 ms



100240

1 sec



100241

2 sec



100242

3 sec



100243



5 sec



100244

8 sec



100245

Send Data

The 4 MB flash memory on the scanner can store up to 246,723 scans based on EAN-13 barcodes. When it is used up, the scanner will respond with two short beeps (high-low tone) as a warning.

You are advised to send data to the host immediately by having the scanner read the "Send Data" barcode below. It will resume the previous WPAN connection with host temporarily.

Send Data



109918

Clear Data & Confirm

Even though data has been sent back to the host, the flash memory is still occupied unless you erase the memory by having the scanner read two barcodes – "Clear Data" and "Confirm".

1. Read the "Clear Data" barcode to clear the flash memory.
2. Read the "Confirm" barcode to confirm the action.

Clear Data



109916

Confirm



109917

1.2.3 FREE MEMORY

You can scan the barcode below to show the available capacity of the flash memory in percentage terms.

Available Memory



109931

1.2.4 RECORD COUNT OF MEMORY

You can scan the barcode below to show the data record count of the flash memory.

Data Record Count
of Memory



109932



1.3 LED INDICATOR

The triple-color LED on top of the scanner is used to provide user feedback. For example, the LED becomes solid red and goes off quickly upon powering on or running out of transmit buffer. You may tell the difference by the beeps – you will hear a long beep of high tone when powering on the scanner, and a long beep of low tone when the transmit buffer becomes full.

Scanner LED			Meaning
Red, flashing	---	---	<ul style="list-style-type: none"> ▶ Charging error(On/Off ratio 0.25 s: 0.25 s) ▶ Configuration Mode (On/Off ratio 0.5 s: 0.5 s)
---	---	Green, solid	<ul style="list-style-type: none"> ▶ The scanner is fully charged.
Red, flashing	---	---	Flashing red 5 times indicates low battery when trying to get into download mode. The task is aborted.
Red, flashing	---	---	Flashing red (On/Off ratio 0.3 s: 2.5 s) indicates the scanner is inactive and its CPU running at low speed to save power — <ul style="list-style-type: none"> ▶ No WPAN connection is established after waiting for two minutes
Red, solid	---	---	<ul style="list-style-type: none"> ▶ Charging
Red, on-off	---	---	<ul style="list-style-type: none"> ▶ Power on, with one long beep (high tone, LED on for 1 second) ▶ Data saved to buffer when transmit buffer is enabled and the scanner is out of range, with two short beeps (high-low tone) ▶ Transmit buffer full, with one long beep (low tone) ▶ Transmit buffer disabled, with one long beep (low tone) ▶ Memory full in memory mode, with two short beeps (high-low tone)
---	---	Green, on-off	Good Read, with one short beep (high tone, LED on for 1 second), and beeper pitch and duration is programmable.
---	Blue, flashing	---	First, flashing blue (On/Off ratio 0.5 s: 0.5 s) for two minutes indicates the scanner is waiting for connection, and goes off if no connection is established, then flashing red (On/Off ratio 0.3 s: 2.5 s) indicates the scanner is inactive. It is ready for connection only while the LED is flashing blue — <ul style="list-style-type: none"> ▶ HID: trying to connect to host
---	Blue, flashing	---	Flashing blue (On/Off ratio 0.1 s: 0.1 s) indicates the scanner receives a PIN code request from host (flashing more quickly than waiting connection).
---	Blue, flashing	---	Flashing blue (On/Off ratio 0.02 s: 3 s) indicates the scanner has established a WPAN connection successfully.
---	Blue, flashing	Green, flashing	Flashing in blue and green colors by turns for 2 seconds (On/Off ratio 0.1 s: 0.1 s) indicate an error occurs while entering the PIN code. Press the trigger to get ready for re-connecting (Default: 2



			minutes).
---		Green, on-off	<p>Press Shutdown key for 3 seconds, and then release for the display of the ring scanner battery power level:</p> <ul style="list-style-type: none"> ■ G1,G2,G3,G4 LEDs on for 1 second --- Battery power Level is 80~100%. ■ G1,G2,G3 LEDs on for 1 second --- Battery power Level is 40~80% ■ G1,G2 LEDs on for 1 second --- Battery power Level is 20%~40%. ■ G1 LED on for 1 second --- Battery power Level is lower than 20%.
Red, flashing		Green, flashing	Flashing in red and green colors for 1 second by turns indicates the firmware transmitted to the ring scanner is updating. Wait for 40 seconds around and do not power off the device during the process of this upgrade. The system will restart when the upgrade is completed.

1.3.1 GOOD READ LED

*Enable
Good Read LED



Disable
Good Read LED



1.3.2 GOOD READ LED DURATION

By default, the Good Read LED stays on for 40 milliseconds. Specify a value, ranging from 1 to 254 in units of 10 milliseconds.

Good Read LED
Time-out after
0.01~2.54 sec.
(*40 ms)



- 1) Read the barcode above to specify the time interval before the Good Read LED goes off.
- 2) Read the "Decimal Value" barcode on Appendix IV. For example, read "1" and "5" for the LED to go off after 150 milliseconds.
- 3) Read the "Validate" barcode on Appendix IV to complete this setting.







1.4 BEEPER

The scanner has a buzzer to give feedback for various operating conditions.

Beeping	Meaning
One long beep, high tone	Power on, with red LED on (1 second) and off quickly
One short beep, high tone ▶ Programmable, default to 4 KHz	Good Read, with green LED on-off quickly
Six short beeps ▶ High-low tone repeats three times	▶ Enter Configuration Mode, with red LED flashing ▶ Exit Configuration Mode
Two short beeps, low-high tone	Read setup barcode successfully
One short beep, high tone	▶ More setup barcode required ▶ Input PIN code ▶ Clear PIN code
One short beep, low tone	More barcodes required to complete the "output sequence" requirements of Multi-Barcode Editor, with green LED on-off quickly (Upon completion, same as Good Read.)
One long beep, low tone	▶ Transmit buffer full, with red LED on-off quickly ▶ Transmit buffer disabled, with red LED on-off quickly ▶ Configuration error (Wrong barcode...) ▶ PIN code input error ▶ Reject random PIN request ▶ Fail to send data in memory mode
Two short beeps, high-low tone	▶ Data saved to buffer when transmit buffer is enabled and the scanner is out of range, with red LED on-off quickly ▶ Memory Mode – Memory full, with red LED on-off quickly
Two short beeps, high tone	Low Battery Alarm
One short beep then one long beep, high-low tone	Indicates low battery when trying to get into download mode. The task is aborted.
Two long beeps, high-low tone	Multi-Barcode Mode – Buffer full
Three short beeps, tone ascending from low to high	▶ WPAN connection is established, with blue LED flashing ▶ WPAN connection is resumed, with blue LED flashing
Three short beeps, tone ascending from high to low	WPAN connection is out of range or suspended



1.4.1 BEEPER VOLUME

Mute	
	101009
Minimum Volume	
	101010
Medium Volume	
	101011
*Maximum Volume	
	101012

1.4.2 GOOD READ BEEP

Frequency

8 kHz	
	101001
*4 kHz	
	101002
2 kHz	
	101003
1 kHz	
	101004

Duration

*Shortest	
	101005



Shorter



101006

Longer



101007

Longest



101008

1.4.3 LOW BATTERY ALARM

By default, it will activate the beeper to give a warning when the battery charge gets low. In order to prevent data loss, you are advised to replace the battery immediately when you hear two short beeps (high tone).

*Low Battery Alarm



101018

No Alarm



101017

Low battery alarm time interval differs depending on the operating status.

Low Battery Alarm Time Interval	Operating Status
1.5 seconds	During scanner operation
10 seconds	The scanner idles for 30 seconds

1.4.4 BELL RING

With this function enabled, the scanner will produce a bell ring when receiving the '0x07' ASCII character which is sent via BLE SPP LITE or USB VCOM CDC interface.

Enable



101051

*Disable



101050



1.4.5 POWER-ON BEEP

By default, the scanner beeps when you press the trigger to power on it. You can have the scanner read the Disable setting barcode below to disable the power-on beep.

Disable



*Enable



1.5 SEND "NR" TO HOST

You may have the scanner send the "NR" string to the host to notify the No Read event by having the scanner read the following Enable setting barcode in order to activate this function.

Enable



*Disable



1.6 SCAN MODES

Different scan modes are supported – select the scan mode that best suits the requirements of a specific application. Refer to the comparison table below.

Scan Mode	Start to Scan					Stop Scanning		
	Always	Press trigger once	Hold trigger	Press trigger twice	Release trigger	Release trigger	Barcode being read	Timeout
Test mode	✓							
Laser mode			✓			✓	✓	✓
Auto Off mode		✓					✓	✓
Auto Power Off mode		✓						✓



Aiming mode (Original)				✓			✓	✓
Aiming mode (Always Aiming)			✓			✓	✓	✓
Aiming mode (Auto Aiming)			✓			✓	✓	✓
Multi-Barcode mode			✓			✓		
Release Mode					✓		✓	✓

Note: By default, the scan mode is set to Laser mode.



1.6.1 TEST MODE

The scanner is always scanning.

- ▶ Capable of decoding the same barcode repeatedly without removing it, for testing purpose.

Test Mode



1.6.2 LASER MODE

The scanner will start scanning once the trigger is held down.

- ▶ The scanning won't stop until (1) a barcode is decoded, (2) the pre-set timeout expires, or (3) you release the trigger.

Note: Refer to [Section 1.7 Scanning Timeout](#).

*Laser Mode



1.6.3 AUTO OFF MODE

The scanner will start scanning once the trigger is pressed.

- ▶ The scanning won't stop until (1) a barcode is decoded, and (2) the pre-set timeout expires.

Note: Refer to [Section 1.7 Scanning Timeout](#).

Auto Off Mode



1.6.4 AUTO POWER OFF MODE

The scanner will start scanning once the trigger is pressed.

- ▶ The scanning won't stop until the pre-set timeout expires, and, the pre-set timeout period re-counts after each successful decoding.

Note: Refer to Sections of [1.8 Delay between Re-read](#) and [1.7 Scanning Timeout](#).

Auto Power Off
Mode



1.6.5 AIMING MODE

Read the Aiming Mode barcode below to switch to aiming mode.

Aiming Mode



Aiming Timeout

You can limit the aiming time interval (1~15). By default, the scanner time-out is set to 1 second.

Aiming Time-out
after 1~15 sec.
(*1)



1. Read the barcode above to specify the time interval before aiming ends. (It is set to 1 by default.)
2. Read the "Decimal Value" barcode on Appendix IV. For example, read "1" and "0" for the scanner to automatically shut down after idleness of 10 seconds.
3. Read the "Validate" barcode on Appendix IV to complete this setting.

AIMING SUBMODES

Users can further specify the submode of the aiming mode.

ORIGINAL MODE:

By default, the scanner will aim at a barcode once the trigger is pressed, and start scanning when the trigger is pressed again within the aiming timeout.

- ▶ The scanning won't stop until (1) a barcode is decoded, and (2) the pre-set timeout expires.

*Original Mode



ALWAYS AIMING:

The scanner is aiming at all times. You are supposed to press the trigger to decode the barcode.



Always Aiming



AUTO AIMING:

The scanner will be expecting barcodes. Whenever a barcode is brought within range, the scanner starts aiming at the barcode. Then you are supposed to press the trigger to decode the barcode.

Auto Aiming



Note: In case the reader (SE4770/SE5500/SE4750MR) of the ring scanner is in "Aiming Mode" and further specify the submode of the aiming mode as either "Always Aiming" or "Auto Aiming" simultaneously, please protect your eyes from the laser aimer.

1.6.6 MULTI-BARCODE MODE

The scanner will be scanning as long as the trigger is held down, capable of decoding one single barcode, as well as multiple unique barcodes one at a time. While decoding a bunch of unique barcodes, if a barcode is decoded twice, its subsequent decoding will be ignored and the scanner is expecting another unique barcode.

- ▶ The scanning won't stop until you release the trigger.

Multi-Barcode Mode



Note:

- (1) A barcode is considered unique when its Code Type or data is different from others.
- (2) Multi-Barcode Mode has nothing to do with the [Section 5.6 Multi-Barcode Editor](#).

1.6.7 RELEASE MODE

The scanner will aim at a barcode once the trigger is pressed, and then start scanning when the trigger is released.

Note: Refer to [Section 1.7 Scanning Timeout](#).

Release Mode



1.7 SCANNING TIMEOUT

Specify the scanning time interval (1~254 sec.; 0= Disable) when the scan mode is set to any of the following –

- ▶ Laser mode
- ▶ Auto Off mode
- ▶ Auto Power Off mode
- ▶ Aiming mode
- ▶ Release mode

Scanner Time-out
after 0~254 sec.
(*10)









- 1) Read the barcode above to specify the time interval before the scan engine times out.
- 2) Read the "Decimal Value" barcode on Appendix IV. For example, read "1" and "5" for the scanner to automatically shut down after being idle for 15 seconds.
- 3) Read the "Validate" barcode on Appendix IV to complete this setting.



1.8 DELAY BETWEEN RE-READ

This is also referred to as the "Blocking Time", which is used to prevent the scanner from accidentally reading the same barcode twice when the scan mode is set to any of the following –

- ▶ Auto Power Off mode
- ▶ Laser mode (with the Auto-sense function working)

100 ms	 100216
200 ms	 100217
*400 ms	 100218
800 ms	 100219
1 sec	 100220
2 sec	 100221
3 sec	 100222
5 sec	 100223



1.9 READ REDUNDANCY (1D)

Select the level of reading security. For example,

- ▶ If "No Redundancy" is selected, one successful decoding will make the reading valid and induce the "READER Event".
- ▶ If "Two Times" is selected, it will take a total of three consecutive successful decoding of the same barcode to make the reading valid. The higher the reading security is (that is, the more redundancy the user selects), the slower the reading speed gets.

It is obvious that the more redundancy you select, the higher the reading security is, and thus, the slower the reading speed becomes. You will have to compromise between reading security and decoding speed.



1.10 ADDON SECURITY FOR UPC/EAN BARCODES

The scanner is capable of decoding a mix of UPC/EAN barcodes with and without addons. The read redundancy (2~16 times; default is set to 10) allows changing the number of times to decode a UPC/EAN barcode before transmission. The more redundancy you select, the higher the reading security is, and thus, the slower the reading speed becomes. You will have to compromise between reading security and decoding speed.

Note: UPC/EAN Addon 2 and Addon 5 must be enabled individually for this setting to take effect.



- 1) Read the barcode above to specify the read redundancy for UPC/EAN barcodes.
- 2) Read the "Decimal Value" barcode on Appendix IV. For example, read "1" and "2" for the scanner to re-read the barcode for 12 times.
- 3) Read the "Validate" barcode on Appendix IV to complete this setting.



1.11 NEGATIVE BARCODES

Normally, barcodes are printed with the color of the bars darker than that of the spaces. But for negative barcodes, they are printed in the opposite sense just like negative films. The spaces of negative barcodes are printed with a color darker than that of the bars. You can configure the scanner to be able to read negative barcodes in the following symbologies:

- ▶ All 1D symbologies
- ▶ Data Matrix
- ▶ QR Code
- ▶ Aztec

Enable



*Disable



1.12 PICKLIST MODE

Picklist Mode enables the decoder to decode only the barcodes aligned at the center under the laser aiming pattern.

Enable



*Disable



1.13 MOBILE PHONE/DISPLAY MODE

By default this mode is disabled. There is a big improvement in reading barcodes displayed on mobile phones and electronic displays when this mode is enabled.

*Disable



Enable



1.14 ILLUMINATION BRIGHTNESS

Users can adjust the illumination brightness of the LED light source. Specify a value ranging from 1 to 10 to set the brightness level which is set to 10 by default meaning 100% illuminated.

illumination
Brightness
(1~*10)



- 1) Read the barcode above to commence the adjustment.
- 2) Read the "Decimal Value" barcode on Appendix IV for the desired illumination brightness level.
- 3) Read the "Validate" barcode on Appendix IV to complete the setting.

Note: LED illumination brightness setup only supports SE4107 and SE4750MR readers.

1.15 SERIAL NUMBER STAMP

Decide whether to add the device serial number in front of the data transmitted.

Add serial number
in front of data



*Disable



1.15.1 SEPARATOR BETWEEN SERIAL NUMBER STAMP AND DATA

Scan the barcode below to specify the separator character between device serial number and the accompanying data. By default, the separator is a comma symbol.

Specify the
separator
character



- 1) Read the barcode above to specify a separator character.
- 2) Read the "[Hexadecimal Value](#)" barcode on Appendix IV for the desired character.
- 3) Read the "Validate" barcode on Appendix IV to complete this setting.



1.16 2D DECODE SETTINGS

1.16.1 AIMING PATTERN

Enable/Disable the aiming pattern during scanning.

***Enable**



Disable



1.16.2 DECODING ILLUMINATION

Enable/Disable illumination during scanning.

- ▶ Enabling illumination usually results in superior images. The effectiveness of the illumination decreases as the distance to the target increases.

***Enable**



Disable



1.17 VIBRATOR SETUP

Besides buzzer and LED, WR30 Ring Scanner, featuring the function of vibrator, also allows the users to know that whether the decoding of the scanned barcode succeeds or not by the haptic alert.

By enabling this vibrator function, the scanner will vibrate upon the time duration you configure in case the barcode is scanned successfully. However, no vibration will be displayed in spite of the scanning result if this function is configured as "Disabled".

To enable or disable this function, users can have the scanner read the setting barcodes below. In addition, you are able to decide that the time duration of scanner's vibration will last by having the scanner read the following setting QR Code you would like.

***Enable Vibrator**



Disable Vibrator



0.1 Second



2 Second



0.2 Second



5 Second



*0.3 Second



0.5 Second



0.8 Second



1 Second



SELECTING OUTPUT INTERFACE

In order to establish a proper WPAN connection between your PC/mobile computer and the scanner, we suggest that you follow these instructions –

- 1) Install the battery and hold down the trigger for about 3 seconds to turn on the scanner.
- 2) Have the scanner read the “Enter Setup” setup barcode to enter the configuration mode.
- 3) Have the scanner read the associated barcodes to activate the desired interface. See the following sections for the output interfaces supported.

Have the scanner read the barcodes for the related settings.

- 4) Have the scanner read the “Update” setup barcode to save the new settings and exit the configuration mode.
 - 5) Turn on your PC or mobile computer and establish a bluetooth connection with the scanner. Refer to [Chapter 3 – Setting up a WPAN Connection](#) for more details.
-

Note: By default, the output interface is set to “BT HID”.

IN THIS CHAPTER

2.1 BT HID	52
2.2 BLE SPP LITE.....	63
2.3 DIRECT USB VCOM CDC	65
2.4 Direct USB HID	67
2.5 RS-232 via WR30 Dongle	77
2.6 Connect USB HID via WR30 Dongle.....	80
2.7 Connect USB VCOM_CDC via WR30 Dongle	90



2.1 BT HID

For BT HID, refer to [Chapter 3 – Setting up a WPAN Connection](#) for related connection settings. No matter the connection is established through BT HID or USB HID, programs such as Notepad.exe can be executed to receive the scanned data sent to PC or the mobile computer.

HID Settings	Defaults
Keyboard Type	PCAT (US)
Alphabets Layout	Normal
Digits Layout	Normal
Capital Lock Type	Normal
Capital Lock State	Off
Alphabets Transmission	Case-sensitive
Digits Transmission	Alphanumeric keypad
Kanji Transmission	Disable
Alternate Composing	No
Inter-Character Delay	0 (ms)
Inter-Function Delay	0 (ms)



2.1.1 ACTIVATE BT HID & SELECT KEYBOARD TYPE

When BT HID interface is activated, you will have to select a keyboard type to complete this setting. By default, BT HID is activated on the scanner, and the keyboard type is set to PCAT (US).

Activate BT HID
(HOGP) & Select
Keyboard Type



- 1) Read the barcode above to activate BT HID and select a keyboard type.
- 2) Read the "Decimal Value" barcode on Appendix IV. Refer to the table below for the number of desired keyboard type.
- 3) Read the "Validate" barcode on Appendix IV to complete this setting.

BT HID

By default, the keyboard type is set to PCAT (US). The following keyboard types are supported —

No.	Keyboard Type	No.	Keyboard Type
1	PCAT (US)	31	PCAT (Hungarian)
2	PCAT (French)	32	PCAT (Switzerland German)
3	PCAT (German)	33	PCAT (Danish)
4	PCAT (Italian)	35	PCAT (Greek)
5	PCAT (Swedish)	37	PCAT (Russian)
6	PCAT (Norwegian)	42	PCAT (Cyrillic on Russian)
7	PCAT (UK)	43	PCAT (Armenian)
8	PCAT (Belgium)	44	PCAT (Thai)
9	PCAT (Spanish)	45	PCAT (Slovenian)
10	PCAT (Portuguese)	46	PCAT (Mexican Spanish)
12	PS55 A01-2 (Japanese)	48	PCAT (Swiss French)
29	User-defined table	49	PCAT (Czech)
30	PCAT (Turkish)		



2.1.2 RESET CONNECTION

For BT HID, you can only have the scanner connected to one computer at a time. If you want to connect the scanner to another host, you must have it read the "Reset Connection" barcode so that the current connection record will be cleared. Then, the scanner will restart itself automatically. Then, the ring scanner will establish a new connection with another computer equipped with Bluetooth wireless technology.

Reset Connection



Note: The "Restore System Defaults" barcode will have the current connection record cleared as well.

2.1.3 KEYBOARD SETTINGS

- ▶ Alphabets Layout
- ▶ Digits Layout
- ▶ Capital Lock Type and Capital Lock Setting
- ▶ Alphabets Transmission
- ▶ Digits Transmission
- ▶ Kanji Transmission
- ▶ Alternate Composing

Note: BT HID does not support these functions on PDAs – (1) Capital Lock Setting: Auto Detection (2) Digits Transmission: Numeric Key

Alphabets Layout

By default, the alphabets layout is set to normal mode, also known as the standard English layout. Select French or German keyboard layout if necessary. The scanner will make adjustments when sending the "A", "Q", "W", "Z", "Y", and "M" characters according to this setting.

*Normal



AZERTY



QWERTZ



Note: This setting only works when the keyboard type is selected as US keyboard, such as PCAT (US). The Alphabets Layout and Digits Layout settings must match your keyboard.



US Keyboard Style – Normal

QWERTY layout, which is normally used in western countries.

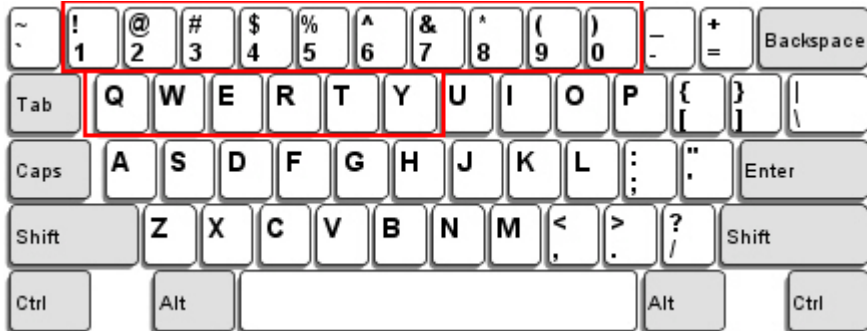

- ▶ Select "Lower Row" for the "Digits Layout" setting because the upper row is for special characters.

French Keyboard Style – AZERTY

French layout; see below for French Keyboard Style.

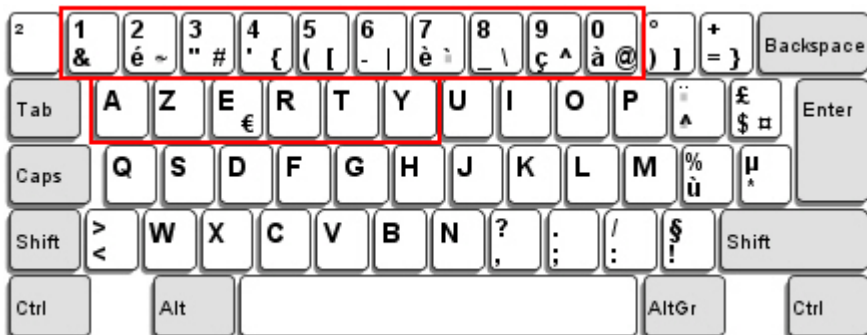

- ▶ Select "Upper Row" for the "Digits Layout" setting because the lower row is for special characters.

German Keyboard Layout – QWERTZ

German layout; see below for German Keyboard Style.

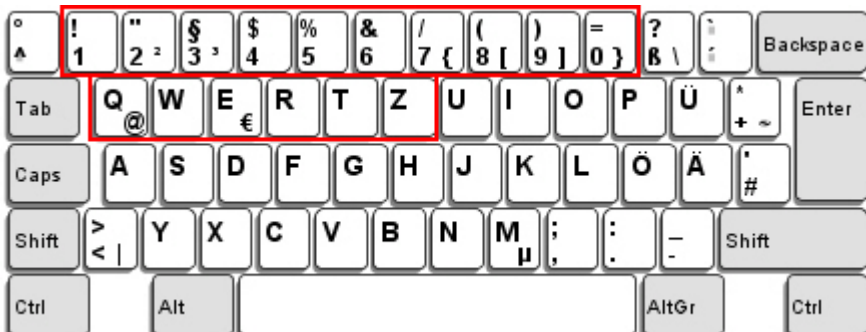

- ▶ Select "Lower Row" for the "Digits Layout" setting because the upper row is for special characters.



Digits Layout

Select a proper layout that matches the alphabets layout. The scanner will make adjustments according to this setting.

Options	Description
Normal	Depends on the [Shift] key or [Shift Lock] setting
Lower Row	For QWERTY or QWERTZ keyboard
Upper Row	For AZERTY keyboard

***Normal**



100046

Upper Row



100049

Lower Row



100048

Note: This setting is to be used with the Character Substitution setting when the certain keyboard types (languages) is unavailable but required.



Capital Lock Type & Setting

In order to send the alphabets with correct case, the scanner needs to know the status of Caps/Shift Lock on the keyboard. Incorrect settings may result in reversed case of the alphabets being transmitted.

Cap Lock Type	Description
Normal	Normal type
Capital Lock	When enabled, the keys of alphabetic characters will be interpreted as capital letters. However, this does not affect the number or punctuation keys.
Shift Lock	When enabled, the keys of alphabetic characters will be interpreted as capital letters. In addition, this affects the number or punctuation keys.

***Normal**



100042

Shift Lock



100045

Capital Lock



100044

Capital Lock State	Description
Capital Lock OFF	Assuming that the status of Caps Lock on the keyboard is OFF, transmitted characters are exactly the same as in the barcode (when "case-sensitive" is selected for Alphabets Transmission).
Capital Lock ON	Assuming that the status of Caps Lock on the keyboard is ON, transmitted characters are exactly the same as in the barcode (when "case-sensitive" is selected for Alphabets Transmission). <ul style="list-style-type: none"> ▶ Refer to the Capital Lock Type above.
Auto Detection	The scanner will automatically detect the status of Caps Lock on the keyboard before data is transmitted; transmitted characters are exactly the same as in the barcode (when "case-sensitive" is selected for Alphabets Transmission). <ul style="list-style-type: none"> ▶ This setting is not supported on PDAs.

Auto Detect



100054

Capital Lock ON



100053



*Capital Lock OFF



Alphabets Transmission

By default, the alphabets transmission is case-sensitive, meaning that the alphabets will be transmitted according to their original case, the status of Caps Lock on the keyboard, as well as the Capital Lock setting. Select [Ignore Case] to have alphabets transmitted according to the status of Caps Lock on the keyboard only.

Ignore Case



*Case-sensitive



Refer to Section 5.1 Letter Case.



1. Letter Case for Output Format



2. Alphabets Transmission for Keyboard Wedge & Bluetooth HID



3a. Check Caps Lock on the keyboard



3b. Check Caps Lock on the keyboard



4. Check Capital Lock setting

*Capital Lock OFF		
Capital Lock ON		
Auto Detection		



Digits Transmission

By default, the alphanumeric keypad is used for transmitting digits. Select "Numeric Keypad" if you wish to use the keys on the numeric keypad.

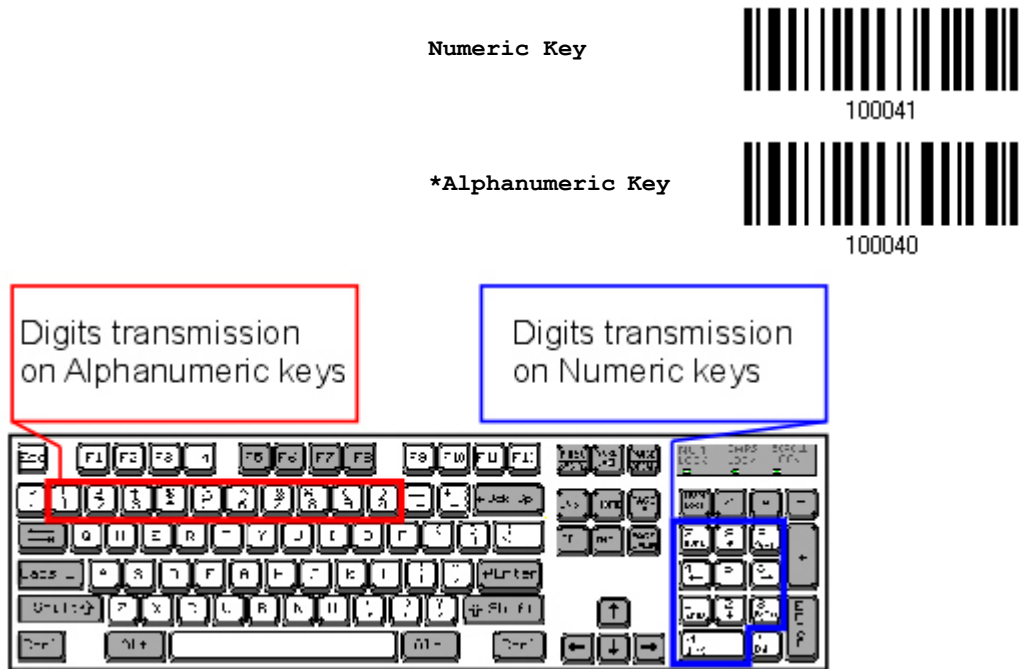

Note: If you select "Numeric Keypad", the Num Lock status of the physical keyboard should be "ON". This setting is not supported on PDAs.

Kanji Transmission

Kanji Transmission is supported by the scanner when Bluetooth HID is selected as the output interface. By Kanji Transmission, when the host computer is running on Japanese Windows O.S., the scanner is able to transmit Japanese characters including the Chinese characters used in modern Japanese writing system.

Kanji Transmission is disabled by default. Enable/disable scanner's Kanji Transmission by reading the following barcodes:



ALT Composing

By default, Alternate key composing is disabled. Select [Yes] to allow emulating Alternate key code of a specific keyboard character. For example, [Alt] + [065] will be sent to host for the character "A" regardless the keyboard type you are using.



Yes



*No



2.1.4 INTER-CHARACTER DELAY

By default, the inter-character delay is set to zero. Specify a value, ranging from 0 to 254 in units of millisecond, to match the computer response time of the keyboard interface. Such delay time is inserted between every character being transmitted. The longer the delay time is, the slower the transmission speed will be.

Inter-Character
Delay... (*0~254)



- 1) Read the barcode above to specify the inter-character delay.
- 2) Read the "Decimal Value" barcode on Appendix IV for the desired inter-character delay (millisecond).
- 3) Read the "Validate" barcode on Appendix IV to complete this setting.

2.1.5 INTER-FUNCTION DELAY

By default, the inter-function delay is set to zero. Specify a value, ranging from 0 to 254 in units of millisecond, to match the computer response time of the keyboard interface. Such delay time is inserted between every function code (0x01 ~ 0x1F) being transmitted. The longer the delay time is, the slower the transmission speed will be.

Inter-Function
Delay... (*0~254)



- 1) Read the barcode above to specify the inter-function delay.
- 2) Read the "Decimal Value" barcode on Appendix IV for the desired inter-function delay (millisecond).
- 3) Read the "Validate" barcode on Appendix IV to complete this setting.



2.1.6 HID CHARACTER TRANSMIT MODE

By default, HID interface sends data to the host character by character. You may have the scanner read the "Batch Processing" barcode to process data in batch.

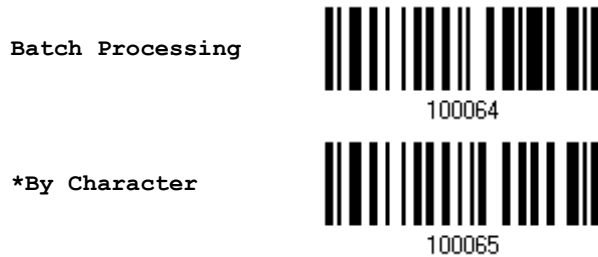

Note: "By Character" transmit mode is required when working with iPhone, iPad or Mac. It's recommended that the Auto-Correction function on your iOS keyboard should be turned off.

▶ iOS support

When you have the scanner read the "Batch Processing" barcode to process data in batch, please enable the iOS support function if you use an iPhone, iPad or Mac to receive the data.



2.1.7 SPECIAL KEYBOARD FEATURE

By default, this interface doesn't employ special function codes (0x01 ~ 0x1F) defined in the Keyboard Wedge Table for users may want to get rid of these special codes within the barcodes to avoid data error.

Or you can enable the "Bypass with Control Character Output for Windows" function to output control characters ranging from 0x01 to 0x1F in text form. For instance, [BS] (the backspace) is output rather than 0x08 when this function is enabled.

You can decide whether to apply the special keyboard feature. For further details please refer to [Appendix III Keyboard Wedge Table](#).



Apply



100018

Bypass with Control
Character Output
for Windows



100020

2.1.8 KEYPAD SUPPORT FOR IPHONE/IPAD

When the scanner has been successfully connected to iPhone or iPad for data collection, the onscreen keypad of iPhone/iPad will disappear by default. Have the scanner read the "Show or Hide Keypad" barcode to show or hide the keypad if necessary.

Show or Hide Keypad

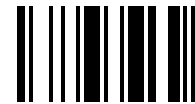

By default, users can show or hide the onscreen keypad by simply pressing the scanner trigger key twice within 0.5 seconds. To disable this function, please read the Disable setting barcode below.

Disable



101022

*Use Trigger Key
to Show or Hide
Keypad



101023

Note: This function only works for
(1) iPhone 4 and 3GS version 4.1 or later, and (2) iPad version 4.2 or later.

2.1.9 TRANSMIT SPEED

By default, the BT HID transmit speed is set to Fast. Users can have the scanner work in normal speed by reading the Normal barcode.

Normal



100162

*Fast



100163



2.1.10 UTF-8 CONVERSION

This function, disabled by default, is only for certain keyboard types listed in the table below. Enable this function to get the UTF-8-encoded data.

No.	Keyboard Type	No.	Keyboard Type
81	PCAT (Greek)	91	PCAT (Slovenian)
83	PCAT (Russian)	92	PCAT (Mexican Spanish)
88	PCAT (Cyrillic on Russian)	94	PCAT (Swiss French)
89	PCAT (Armenian)	95	PCAT (Czech)
90	PCAT (Thai)		

Enable



*Disable



2.2 BLE SPP LITE

To establish a WPAN connection for the ring scanner, refer to [Chapter 3 – Setting up a WPAN Connection](#) for the related connection settings.

2.2.1 ACTIVATE BLE SPP LITE MODE

Scan the barcode below to have the scanner get into BLE (Bluetooth Low Energy) SPP Lite mode.

Activate BLE SPP
LITE



To use this interface, you must develop your own application program in order for the data transmission between the host computer (e.g. Android platform) and the scanner. Refer to the list below for TX/RX Characteristic UUID required for the scanner data transmission and reception.

BLE SPP Lite Tx Characteristic UUID	▶ 6e400003-b5a3-f393-e0a9-e50e24dcca9e
BLE SPP Lite Rx Characteristic UUID	▶ 6e400002-b5a3-f393-e0a9-e50e24dcca9e



2.2.2 INTER-FUNCTION DELAY

By default, the inter-function delay is set to zero. Specify a value, ranging from 0 to 254 in units of millisecond, to match the computer response time of the keyboard interface. Such delay time is inserted between every function code (0x01 ~ 0x1F) being transmitted. The longer the delay time is, the slower the transmission speed will be.

Inter-Function
Delay... (*0~254)



100012

- 1) Read the barcode above to specify the inter-function delay.
- 2) Read the "Decimal Value" barcode on Appendix IV for the desired inter-function delay (millisecond).
- 3) Read the "Validate" barcode on Appendix IV to complete this setting.

2.2.3 ACK/NAK TIMEOUT

By default, the scanner sends data to the host without waiting for an ACK/NAK response before sending more data. Specify a value, ranging from 0 to 99 in units of 0.1 second. If no response within the specified period of time, the scanner will attempt to send the same data two more times. If all three successive attempts fail without any notification, data loss will occur.

ACK/NAK Time-out
after ... (*0~99)



100013

- 1) Read the barcode above to specify the time interval for the scanner to send data and wait for a response from the host.
- 2) Read the "Decimal Value" barcode on Appendix IV. For example, read "1" and "0" for the scanner to automatically shut down after being idle for 1 second.
- 3) Read the "Validate" barcode on Appendix IV to complete this setting.

ACK/NAK Error Beep

Enable Error Beep



100015

*Disable Error
Beep



100014

Note: We suggest enabling the error beep so that you will be notified of such data loss and have the scanner re-read data.



2.2.4 BLE SPP LITE HARDWARE FLOW CONTROL

By default, the data sending via BLE SPP LITE does not employ hardware flow control. In some cases, users may want to enable hardware flow control to prevent the data loss during the transmission. Please scan the barcode below to enable or disable it.

*Disable



100173

Enable



100174

2.3 DIRECT USB VCOM CDC

If you choose to use the USB VCOM CDC interface, have the ring scanner read the "Activate Direct USB VCOM CDC" barcode below first, then connect one end of the USB cable to the scanner and the other end to the computer. Then, execute HyperTerminal.exe to receive the data sent to the computer.

Warning : The power supply cord must be connected when using USB. (It may be insufficient to keep Ring Scanner running normally with the power supplied by USB.)

Note: If it is the first time to use USB VCOM CDC, you are required to install the driver first. Or there is an old version installed, you need to re-install the new version of the driver after removing it

2.3.1 ACTIVATE USB VCOM CDC

To enable USB VCOM CDC, please have the scanner read the barcode below.

Activate Direct
USB VCOM CDC



100010

2.3.2 INTER-FUNCTION DELAY

By default, the inter-function delay is set to zero. Specify a value, ranging from 0 to 254 in units of millisecond, to match the computer response time of the keyboard interface. Such delay time is inserted between every function code (0x01 ~ 0x1F) being transmitted. The longer the delay time is, the slower the transmission speed will be.

Inter-Function
Delay... (*0~254)



100012



- 1) Read the barcode above to specify the inter-function delay.
- 2) Read the "Decimal Value" barcode on Appendix IV for the desired inter-function delay (millisecond).
- 3) Read the "Validate" barcode on Appendix IV to complete this setting.

2.3.3 ACK/NAK TIMEOUT

By default, the scanner sends data to the host without waiting for an ACK/NAK response before sending more data. Specify a value, ranging from 0 to 99 in units of 0.1 second. If no response within the specified period of time, the scanner will attempt to send the same data two more times. If all three successive attempts fail without any notification, data loss will occur.

ACK/NAK Time-out
after ... (*0~99)



- 1) Read the barcode above to specify the time interval for the scanner to send data and wait for a response from the host.
- 2) Read the "Decimal Value" barcode on Appendix IV. For example, read "1" and "0" for the scanner to automatically shut down after being idle for 1 second.
- 3) Read the "Validate" barcode on Appendix IV to complete this setting.

ACK/NAK Error Beep

Enable Error Beep



*Disable Error
Beep



Note: We suggest enabling the error beep so that you will be notified of such data loss and have the scanner re-read data.



2.4 DIRECT USB HID

Connect one end of the USB cable to the bottom of the ring scanner and the other end to the computer. The scanner will be able to receive the data sent to PC by executing Notepad.exe on PC.

Items of HID Settings	Defaults
Keyboard Type	PCAT (US)
Digits Layout	Normal
Capital Lock Type	Normal
Capital Lock State	Off
Alphabets Transmission	Case-sensitive
Digits Transmission	Alphanumeric keypad
Kanji Transmission	Disable
Inter-Character Delay	0 (ms)
Inter-Function Delay	0 (ms)
Alternate Composing	No

2.4.1 ACTIVATE USB HID & SELECT KEYBOARD TYPE

When USB HID interface is activated, you will have to select a keyboard type to complete this setting.

Activate
Direct USB HID &
Select Keyboard
Type...



- 1) Read this barcode above to activate USB HID and select a keyboard type.
- 2) Read the "Decimal Value" barcode on Appendix IV. Refer to the table below for the number of desired keyboard type.
- 3) Read the "Validate" barcode on Appendix IV to complete this setting.



USB HID Keyboard Type

By default, the keyboard type is set to PCAT (US). The following keyboard types are supported.

No.	Keyboard Type	No.	Keyboard Type
64	PCAT (US)	80	Reserved
65	PCAT (French)	81	PCAT (Greek)
66	PCAT (German)	82	Reserved
67	PCAT (Italy)	83	PCAT (Russian)
68	PCAT (Swedish)	84	Reserved
69	PCAT (Norwegian)	85	Reserved
70	PCAT (UK)	86	Reserved
71	PCAT (Belgium)	87	Reserved
72	PCAT (Spanish)	88	PCAT (Cyrillic on Russian)
73	PCAT (Portuguese)	89	PCAT (Armenian)
74	PS55 A01-2 (Japanese)	90	PCAT (Thai)
75	User-defined table	91	PCAT (Slovenian)
76	PCAT (Turkish)	92	PCAT (Mexican Spanish)
77	PCAT (Hungarian)	93	Reserved
78	PCAT (Swiss German)	94	PCAT (Swiss French)
79	PCAT (Danish)	95	PCAT (Czech)



2.4.2 KEYBOARD SETTINGS

- ▶ Alphabets Layout
- ▶ Digits Layout
- ▶ Capital Lock Type & Capital Lock Setting
- ▶ Alphabets Transmission
- ▶ Digits Transmission
- ▶ Kanji Transmission
- ▶ Alternate Composing

Alphabets Layout

By default, the alphabets layout is set to normal mode, also known as the standard English layout. Select French or German keyboard layout if necessary. The scanner will make adjustments when sending the "A", "Q", "W", "Z", "Y", and "M" characters according to this setting.

***Normal**



100060

AZERTY



100061

QWERTZ



100062

Note: This setting only works when the keyboard type is selected as US keyboard, such as PCAT (US). The settings of Alphabets Layout and Digits Layout must match your keyboard.



US Keyboard Style – Normal

QWERTY layout, which is normally used in western countries.

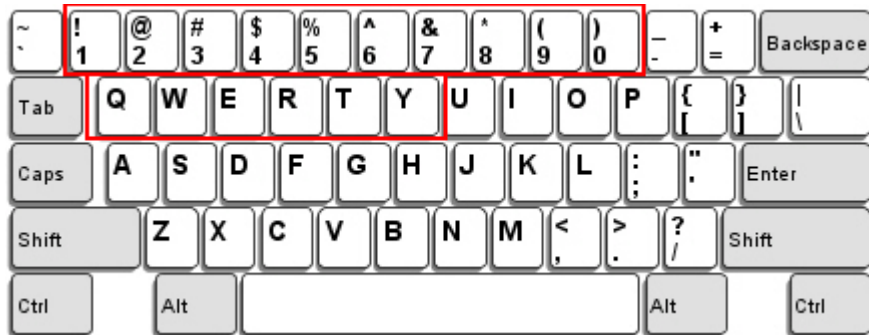

- ▶ Select "Lower Row" for the "Digits Layout" setting because the upper row is for special characters.

French Keyboard Style – AZERTY

French layout; see below for French Keyboard Style.

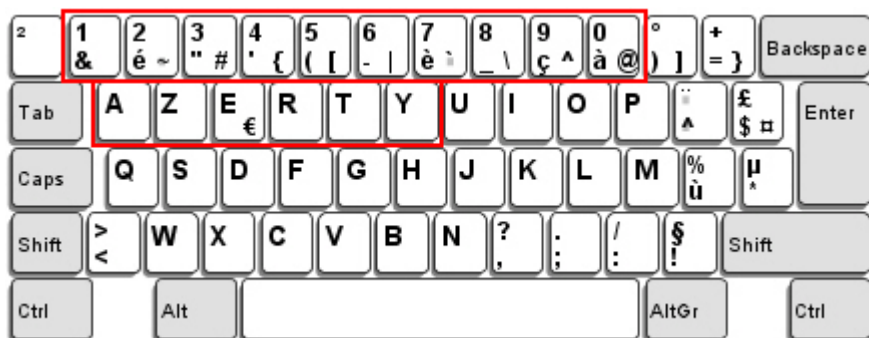

- ▶ Select "Upper Row" for the "Digits Layout" setting because the lower row is for special characters.

German Keyboard Layout – QWERTZ

German layout; see below for German Keyboard Style.

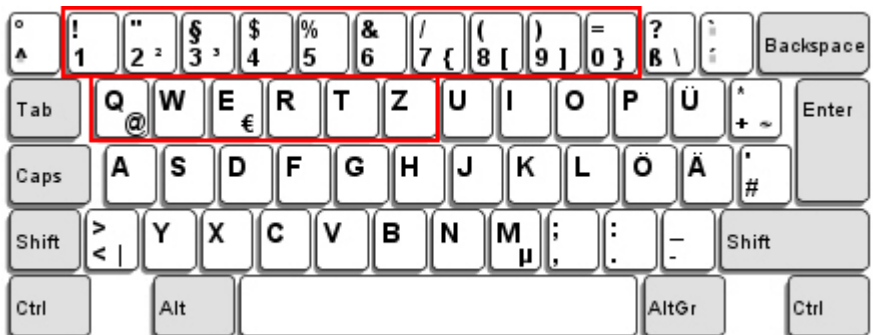

- ▶ Select "Lower Row" for the "Digits Layout" setting because the upper row is for special characters.



Digits Layout

By default, the digits layout is set to normal mode. Select a proper layout that matches the alphabets layout. The scanner will make adjustments according to this setting.

Options	Description
Normal	Depends on the [Shift] key or [Shift Lock] setting
Lower Row	For QWERTY or QWERTZ keyboards
Upper Row	For AZERTY keyboard

***Normal**



Upper Row



Lower Row



Note: This setting is meant to be used with the Alphabets Layout; and perhaps with the Character Substitution setting when support to certain keyboard types (languages) is unavailable but required.

Capital Lock Type & Setting

In order to send the alphabets with correct case, the scanner needs to know the status of Caps/Shift Lock on the keyboard. Incorrect settings may result in reversed case of the alphabets being transmitted.

Cap Lock Type	Description
Normal	Normal type
Capital Lock	When enabled, the keys of alphabetic characters will be interpreted as capital letters. However, this does not affect the number or punctuation keys.
Shift Lock	When enabled, the keys of alphabetic characters will be interpreted as capital letters. In addition, this affects the number or punctuation keys.

***Normal**



Shift Lock



Capital Lock



100044

Capital Lock State	Description
Capital Lock OFF	Assuming that the status of Caps Lock on the keyboard is OFF, transmitted characters are exactly the same as in the barcode (when "case-sensitive" is selected for Alphabets Transmission).
Capital Lock ON	Assuming that the status of Caps Lock on the keyboard is ON, transmitted characters are exactly the same as in the barcode (when "case-sensitive" is selected for Alphabets Transmission). ▶ Refer to the Caps/Shift Lock Type above.
Auto Detection	The scanner will automatically detect the status of Caps Lock on the keyboard before data is transmitted; transmitted characters are exactly the same as in the barcode (when "case-sensitive" is selected for Alphabets Transmission).

Auto Detect



100054

Capital Lock ON



100053

*Capital Lock OFF



100052

Alphabets Transmission

By default, the alphabets transmission is case-sensitive, meaning that the alphabets will be transmitted according to their original case, the status of Caps Lock on the keyboard, as well as the Caps/Shift Lock setting. Select [Ignore Case] to have alphabets transmitted according to the status of Caps Lock on the keyboard only.

Ignore Case



100051

*Case-sensitive



100050



Refer to Section 5.1 Letter Case.

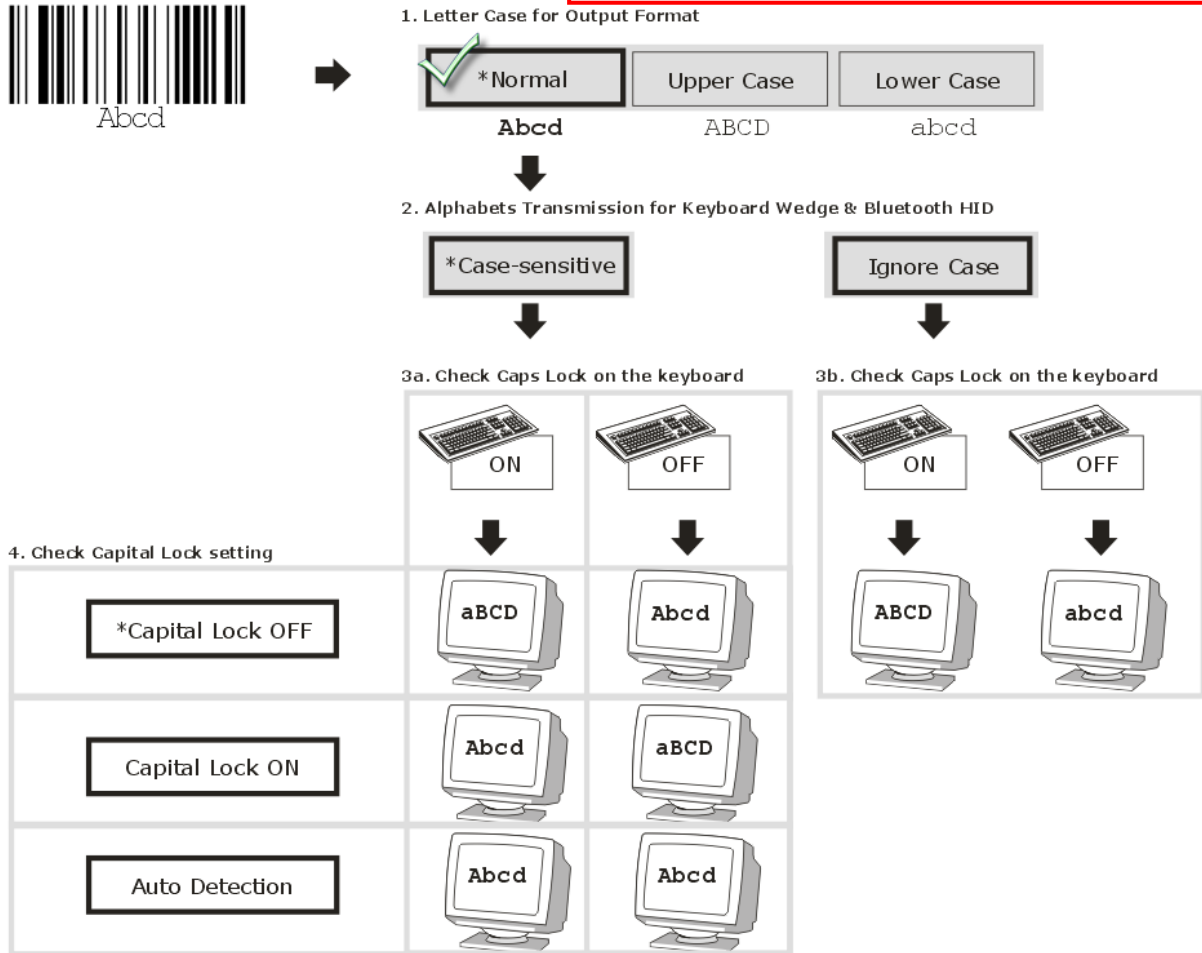

Digits Transmission

By default, the alphanumeric keypad is used for transmitting digits. Select "Numeric Keypad" if you wish to use the keys on the numeric keypad.

Numeric Key



*Alphanumeric Key



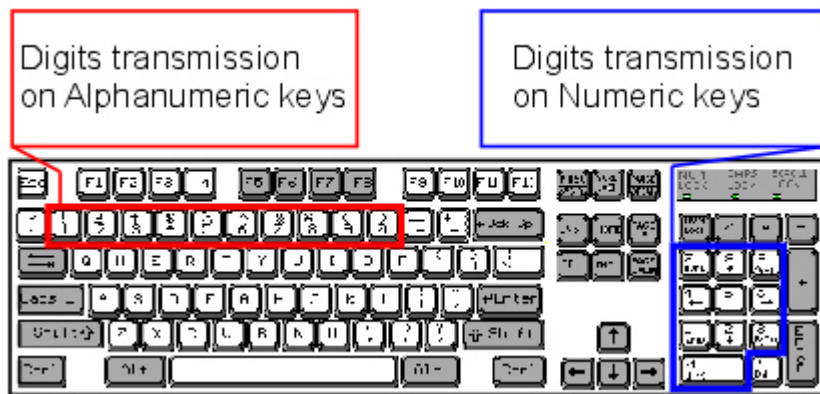

Note: If you select "Numeric Keypad", the Num Lock status of the physical keyboard should be "ON".

Kanji Transmission

Kanji Transmission is supported by the scanner when either BT HID or Direct USB HID is selected as the output interface. By Kanji Transmission, when the host computer is running on Japanese Windows O.S., the Japanese characters of the 2D barcode can be output.

Kanji Transmission is disabled by default. To enable or disable Kanji Transmission, please have the scanner read the following barcodes:

Enable



100067

*Disable



100066

ALT Composing

By default, Alternate key composing is disabled. Select [Yes] to allow emulating Alternate key code of a specific keyboard character. For example, [Alt] + [065] will be sent to host for the character "A" regardless the keyboard type you are using when ALT Composing is enabled.

Yes



100057

*No



100056



2.4.3 INTER-CHARACTER DELAY

By default, the inter-character delay is set to zero. Specify a value, ranging from 0 to 254 in units of millisecond, to match the computer response time of the keyboard interface. Such delay time is inserted between every character being transmitted. The longer the delay time is, the slower the transmission speed will be.

Inter-Character
Delay... (*0~254)



- 1) Read the barcode above to specify the inter-character delay.
- 2) Read the "Decimal Value" barcode on Appendix IV for the desired inter-character delay (millisecond).
- 3) Read the "Validate" barcode on Appendix IV to complete this setting.

2.4.4 INTER-FUNCTION DELAY

By default, the inter-function delay is set to zero. Specify a value, ranging from 0 to 254 in units of millisecond, to match the computer response time of the keyboard interface. Such delay time is inserted between every function code (0x01 ~ 0x1F) being transmitted. The longer the delay time is, the slower the transmission speed will be.

Inter-Function
Delay... (*0~254)



- 1) Read the barcode above to specify the inter-function delay.
- 2) Read the "Decimal Value" barcode on Appendix IV for the desired inter-function delay (millisecond).
- 3) Read the "Validate" barcode on Appendix IV to complete this setting.

2.4.5 HID CHARACTER TRANSMISSION MODE

By default, only one character is transmitted at a time in HID character transmission mode. Read the "Batch Processing" setup barcode below to transmit each data in batches.

Batch Processing



*By Character



Note : If you use an iPhone, iPad or Mac to receive the data, please activate the "By Character" function. It is recommended to disable the Auto-Correction function of the iOS keyboard.

▶ iOS support

When you have the scanner read the "Batch Processing" barcode to process data in batch, please enable the iOS support function if you use an iPhone, iPad or Mac to receive the data.



2.4.6 SPECIAL KEYBOARD

Refer to [Section 2.1.7 Special Keyboard Feature](#).

2.4.7 UTF-8 CONVERSION

By default, UTF-8 Conversion is disabled. It only works on the keyboard types listed on the following table.

No.	Keyboard Type	No.	Keyboard Type
81	PCAT (Greek)	91	PCAT (Slovenian)
83	PCAT (Russian)	92	PCAT (Mexican Spanish)
88	PCAT (Cyrillic on Russian)	94	PCAT (Swiss French)
89	PCAT (Armenian)	95	PCAT (Czech)
90	PCAT (Thai)		



2.5 RS-232 VIA WR30 DONGLE

Connect WR30 Dongle RS232 to the serial port of PC, and connect the 5V DC power supply with the mini-USB port of WR30 Dongle RS232 using the mini-USB cable. To establish a connection between the ring scanner and WR30 Dongle RS232, the associated RS-232 parameters must match those configured on the computer. You may run HyperTerminal.exe on your computer, and the scanned data will be transmitted to the computer.

RS-232 Settings	Defaults
Baud Rate, Data Bit, Parity, Stop Bit	115200 bps, 8 bits, No parity, 1 stop bit
Flow Control	None
Inter-Character Delay	0 (ms)
Inter-Function Delay	0 (ms)
ACK/NAK Timeout	0
ACK/NAK Beep	Disable

2.5.1 ACTIVATE RS-232 INTERFACE

Activate RS-232
Interface



2.5.2 BAUD RATE

*115200 bps



57600 bps



38400 bps



19200 bps



9600 bps



4800 bps



100100

2400 bps



100085

1200 bps



100086

2.5.3 PARITY

*No parity



100088

Even



100090

2.5.4 INTER-FUNCTION DELAY

By default, the inter-function delay is set to zero. Specify a value, ranging from 0 to 254 in units of millisecond, to match the computer response time of the keyboard interface. Such delay time is inserted between every function code (0x01 ~ 0x1F) being transmitted. The longer the delay time is, the slower the transmission speed will be.

Inter-Function
Delay... (*0~254)



100012

- 1) Read this barcode above to specify the inter-function delay.
- 2) Read the "Decimal Value" barcode on Appendix IV for the desired inter-function delay (millisecond).
- 3) Read the "Validate" barcode on Appendix IV to complete this setting.



2.5.5 ACK/NAK TIMEOUT

By default, the scanner sends data to the host without waiting for an ACK/NAK response before sending more data. Specify a value, ranging from 1 to 99 in units of 0.1 second. If no response within the specified period of time, the scanner will attempt to send the same data two more times. If all three attempts fail without any notification, data loss will occur.

ACK/NAK Time-out
after ... (*0~99)



100013

- 1) Read the barcode above to specify the time interval for the scanner to send data and wait for a response from the host.
- 2) Read the "Decimal Value" barcode on Appendix IV. For example, read "1" and "0" for the scanner to automatically shut down after being idle for 1 second.
- 3) Read the "Validate" barcode on Appendix IV to complete this setting.

ACK/NAK Error Beep

Enable Error Beep



100015

*Disable Error
Beep



100014

Note: We suggest enabling the error beep so that you will be notified of such data loss and have the scanner re-read data.



2.6 CONNECT USB HID VIA WR30 DONGLE

For USB HID, connect the scanner via WR30 Dongle to the USB port of PC. Run any text editor(e.g. Notepad.exe) on your computer, and the scanned data will be transmitted to the computer.

Note: The OS on PC only supports Windows 10 or above.

HID Settings	Defaults
Keyboard Type	PCAT (US)
Digits Layout	Normal
Capital Lock Type	Normal
Capital Lock State	Off
Alphabets Transmission	Case-sensitive
Digits Transmission	Alphanumeric keypad
Kanji Transmission	Disable
Alternate Composing	No
Inter-Character Delay	0 (ms)
Inter-Function Delay	0 (ms)



2.6.1 ACTIVATE USB HID & SELECT KEYBOARD TYPE

When USB HID interface is activated, you will have to select a keyboard type to complete this setting.

Activate
Remote USB HID &
Select Keyboard
Type...



- 1) Read the barcode above to activate USB HID and select a keyboard type.
- 2) Read the "Decimal Value" barcode on Appendix IV. Refer to the table below for the number of desired keyboard type.
- 3) Read the "Validate" barcode on Appendix IV to complete this setting.

USB HID

By default, the keyboard type is set to PCAT (US). The following keyboard types are supported —

No.	Keyboard Type	No.	Keyboard Type
64	PCAT (US)	80	Reserved
65	PCAT (French)	81	PCAT (Greek)
66	PCAT (German)	82	Reserved
67	PCAT (Italy)	83	PCAT (Russian)
68	PCAT (Swedish)	84	Reserved
69	PCAT (Norwegian)	85	Reserved
70	PCAT (UK)	86	Reserved
71	PCAT (Belgium)	87	Reserved
72	PCAT (Spanish)	88	PCAT (Cyrillic)
73	PCAT (Portuguese)	89	PCAT (Armenian)
74	PS55 A01-2 (Japanese)	90	PCAT (Thai)
75	User-defined table	91	PCAT (Slovenian)
76	PCAT (Turkish)	92	PCAT (Mexican Spanish)
77	PCAT (Hungarian)	94	PCAT (Swiss French)
78	PCAT (Swiss German)	95	PCAT (Czech)
79	PCAT (Danish)		



2.6.2 KEYBOARD SETTINGS

- ▶ Alphabets Layout
- ▶ Digits Layout
- ▶ Capital Lock Type
- ▶ Capital Lock Setting
- ▶ Alphabets Transmission
- ▶ Digits Transmission
- ▶ Kanji Transmission
- ▶ Alternate Composing

Alphabets Layout

By default, the alphabets layout is set to normal mode, also known as the standard English layout. Select French or German keyboard layout if necessary. The scanner will make adjustments when sending the "A", "Q", "W", "Z", "Y", and "M" characters according to this setting.

***Normal**



AZERTY



QWERTZ



Note: This setting only works when the keyboard type selected is US keyboard, such as PCAT (US). The Alphabets Layout and Digits Layout setting must match your keyboard.



US Keyboard Style – Normal

QWERTY layout, which is normally used in western countries.

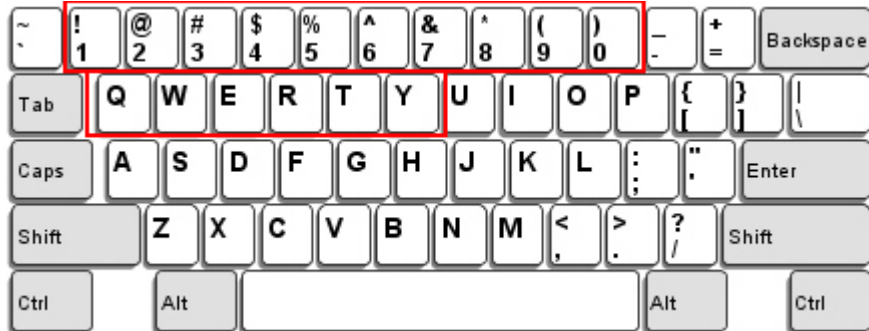

- ▶ Select "Lower Row" for the "Digits Layout" setting because the upper row is for special characters.

French Keyboard Style – AZERTY

French layout; see below for French Keyboard Style.

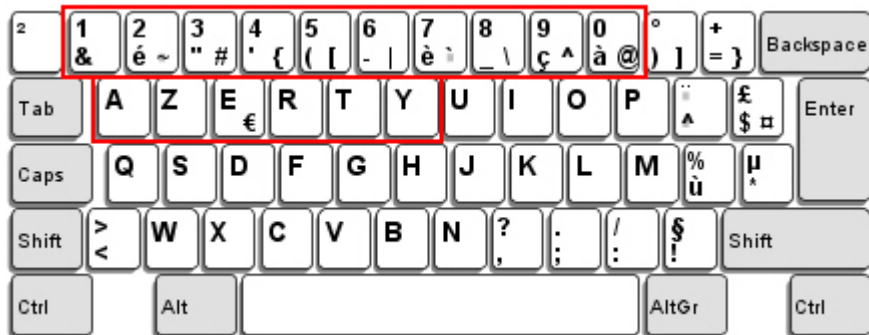

- ▶ Select "Upper Row" for the "Digits Layout" setting because the lower row is for special characters.

German Keyboard Layout – QWERTZ

German layout; see below for German Keyboard Style.

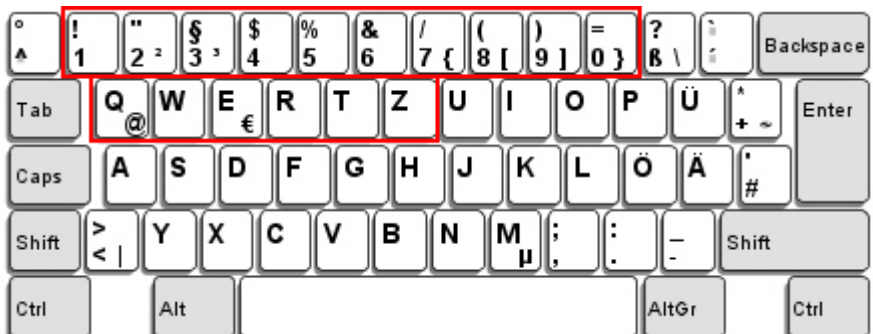

- ▶ Select "Lower Row" for the "Digits Layout" setting because the upper row is for special characters.



Digits Layout

Select a proper layout that matches the alphabets layout. The scanner will make adjustments according to this setting.

Options	Description
Normal	Depends on the [Shift] key or [Shift Lock] setting
Lower Row	For QWERTY or QWERTZ keyboard
Upper Row	For AZERTY keyboard

***Normal**



Upper Row



Lower Row



Note: This setting is to be used with the Character Substitution setting when support to certain keyboard types (languages) is unavailable but required.

Capital Lock Type & Setting

In order to send the alphabets with correct case, the scanner needs to know the status of Caps Lock on the keyboard. Incorrect settings may result in reversed case of the alphabets being transmitted.

Cap Lock Type	Description
Normal	Normal type
Capital Lock	When enabled, the keys of alphabetic characters will be interpreted as capital letters. However, this does not affect the number or punctuation keys.
Shift Lock	When enabled, the keys of alphabetic characters will be interpreted as capital letters. In addition, this affects the number or punctuation keys.

***Normal**



Shift Lock



Capital Lock



100044

Capital Lock State	Description
Capital Lock OFF	Assuming that the status of Caps Lock on the keyboard is OFF, transmitted characters are exactly the same as in the barcode (when "case-sensitive" is selected for Alphabets Transmission).
Capital Lock ON	Assuming that the status of Caps Lock on the keyboard is ON, transmitted characters are exactly the same as in the barcode (when "case-sensitive" is selected for Alphabets Transmission). ▶ Refer to the Capital Lock Type above.
Auto Detection	The scanner will automatically detect the status of Caps Lock on the keyboard before data is transmitted; transmitted characters are exactly the same as in the barcode (when "case-sensitive" is selected for Alphabets Transmission).

Auto Detect



100054

Capital Lock ON



100053

*Capital Lock OFF



100052

Alphabets Transmission

By default, the alphabets transmission is case-sensitive, meaning that the alphabets will be transmitted according to their original case, the status of Caps Lock on the keyboard, as well as the Capital Lock setting. Select [Ignore Case] to have alphabets transmitted according to the status of Caps Lock on the keyboard only.

Ignore Case



100051

*Case-sensitive



100050



Refer to Section 5.1 Letter Case.

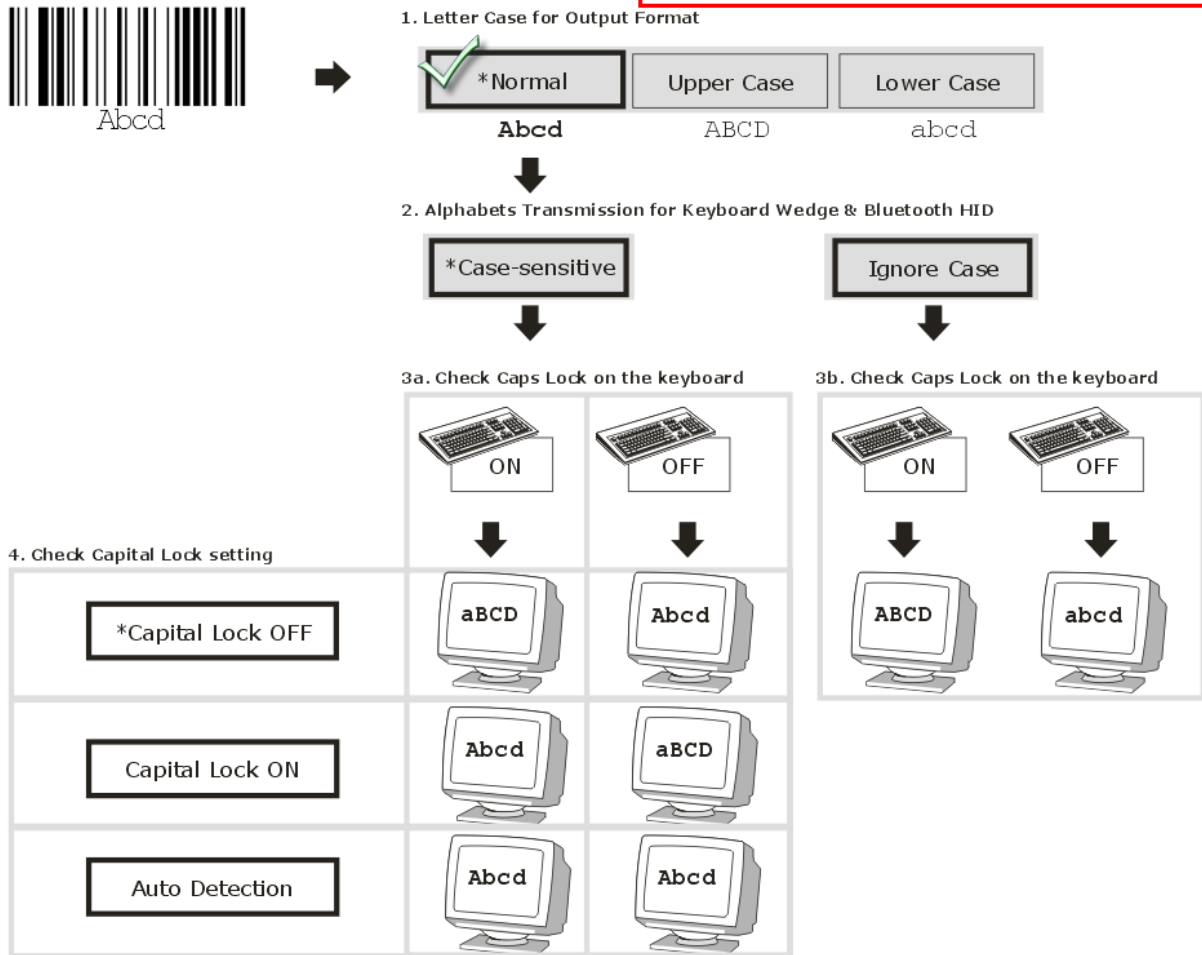

Digits Transmission

By default, the alphanumeric keypad is used for transmitting digits. Select "Numeric Keypad" if you wish to use the keys on the numeric keypad.

Numeric Key



*Alphanumeric Key



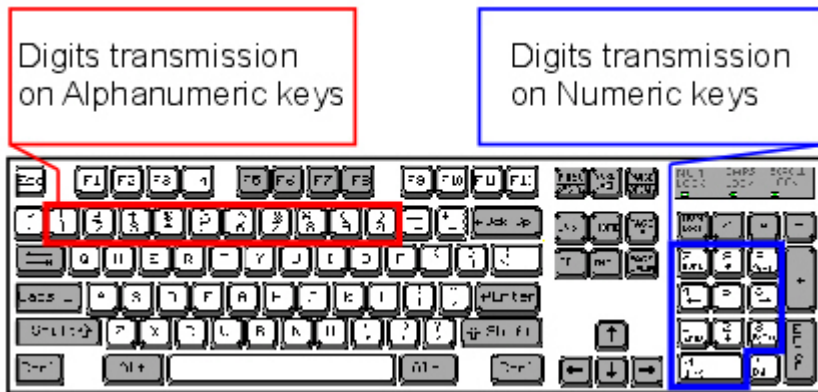

Note: If you select "Numeric Keypad", the Num Lock status of the physical keyboard should be "ON".

Kanji Transmission

Kanji Transmission is supported by the scanner when either Bluetooth HID or Remote USB HID via WR30 Dongle is selected as the output interface. By Kanji Transmission, when the host computer is running on Japanese Windows O.S., the scanner is able to transmit Japanese characters including the Chinese characters used in modern Japanese writing system.

Kanji Transmission is disabled by default. Enable/disable scanner's Kanji Transmission by reading the following barcodes:

Enable



*Disable



ALT Composing

By default, Alternate key composing is disabled. Select [Yes] to allow emulating Alternate key code of a specific keyboard character. For example, [Alt] + [065] will be sent to host for the character "A" regardless the keyboard type you are using.

Yes



*No



2.6.3 INTER-CHARACTER DELAY

By default, the inter-character delay is set to zero. Specify a value, ranging from 0 to 254 in units of millisecond, to match the computer response time of the keyboard interface. Such delay time is inserted between every character being transmitted. The longer the delay time is, the slower the transmission speed will be.

Inter-Character
Delay... (*0~254)



- 1) Read the barcode above to specify the inter-character delay.
- 2) Read the "Decimal Value" barcode on Appendix IV for the desired inter-character delay (millisecond).
- 3) Read the "Validate" barcode on Appendix IV to complete this setting.

2.6.4 INTER-FUNCTION DELAY

By default, the inter-function delay is set to zero. Specify a value, ranging from 0 to 254 in units of millisecond, to match the computer response time of the keyboard interface. Such delay time is inserted between every function code (0x01 ~ 0x1F) being transmitted. The longer the delay time is, the slower the transmission speed will be.

Inter-Function
Delay... (*0~254)



- 1) Read the barcode above to specify the inter-function delay.
- 2) Read the "Decimal Value" barcode on Appendix IV for the desired inter-function delay (millisecond).
- 3) Read the "Validate" barcode on Appendix IV to complete this setting.

2.6.5 HID CHARACTER TRANSMIT MODE

By default, HID interface sends data to the host character by character. You may have the scanner read the "Batch Processing" barcode to process data in batch.

Batch Processing



*By Character



▶ iOS support

When you have the scanner read the "Batch Processing" barcode to process data in batch, please enable the iOS support function if you use an iPhone, iPad or Mac to receive the data.

Enable



100176

*Disable



100175

2.6.6 SPECIAL KEYBOARD FEATURE

Please refer to [Section 2.1.7 Special Keyboard Feature](#).

2.6.7 USB HID VIA WR30 DONGLE AUTO-RECONNECTION

Users can decide whether to have the scanner automatically reconnect to a paired device after disconnection, and the occasion for reconnecting.

*Auto reconnect immediately



100168

Auto reconnect on data being scanned



100169

Auto reconnect off



100170

2.6.8 UTF-8 CONVERSION

Please refer to [Section 2.1.10 UTF-8 Conversion](#).



2.7 CONNECT USB VCOM_CDC VIA WR30 DONGLE

For USB VCOM_CDC, connect the scanner via WR30 Dongle to the USB port of PC. You may run HyperTerminal.exe on your computer, and the scanned data will be transmitted to the computer.

Note: WR30 Dongle only supports Windows 10 operating system or above.

2.7.1 ACTIVATE USB VCOM_CDC

Activate Remote
USB VCOM_CDC



2.7.2 INTER-FUNCTION DELAY

By default, the inter-function delay is set to zero. Specify a value, ranging from 0 to 254 in units of millisecond, to match the computer response time of the keyboard interface. Such delay time is inserted between every function code (0x01 ~ 0x1F) being transmitted. The longer the delay time is, the slower the transmission speed will be.

Inter-Function
Delay... (*0~254)



- 1) Read the barcode above to specify the inter-function delay.
- 2) Read the "Decimal Value" barcode on Appendix IV for the desired inter-function delay (millisecond).
- 3) Read the "Validate" barcode on Appendix IV to complete this setting.

2.7.3 ACK/NAK TIMEOUT

By default, the scanner sends data to the host without waiting for an ACK/NAK response before sending more data. Specify a value, ranging from 1 to 99 in units of 0.1 second. If no response within the specified period of time, the scanner will attempt to send the same data two more times. If all three attempts fail without any notification, data loss will occur.

ACK/NAK Time-out
after ... (*0~99)



- 1) Read the barcode above to specify the time interval for the scanner to send data and wait for a response from the host.
- 2) Read the "Decimal Value" barcode on Appendix IV. For example, read "1" and "0" for the scanner to automatically shut down after being idle for 1 second.
- 3) Read the "Validate" barcode on Appendix IV to complete this setting.



ACK/NAK Error Beep

Enable Error Beep



100015

***Disable Error Beep**



100014

Note: We suggest enabling the error beep so that you will be notified of such data loss and have the scanner re-read data.

2.7.4 USB VCOM_CDC VIA WR30 DONGLE AUTO-RECONNECTION

Users can decide whether to have the scanner automatically reconnect to a paired device after disconnection, and the occasion for reconnecting.

***Auto reconnect immediately**



100168

Auto reconnect on data being scanned



100169

Auto reconnect off



100170



SETTING UP A WPAN CONNECTION

The scanner can be configured to send data to a mobile computer or PC with *Bluetooth*[®] wireless technology. Upon powering up, the scanner will be ready for establishing a WPAN connection.

Transmit Data to Mobile Computer via Bluetooth HID ...



Interface	Reference
Bluetooth HID (BLE HOGP)	2.1 BT HID

Transmit Data to Mobile Computer via BLE SPP LITE ...

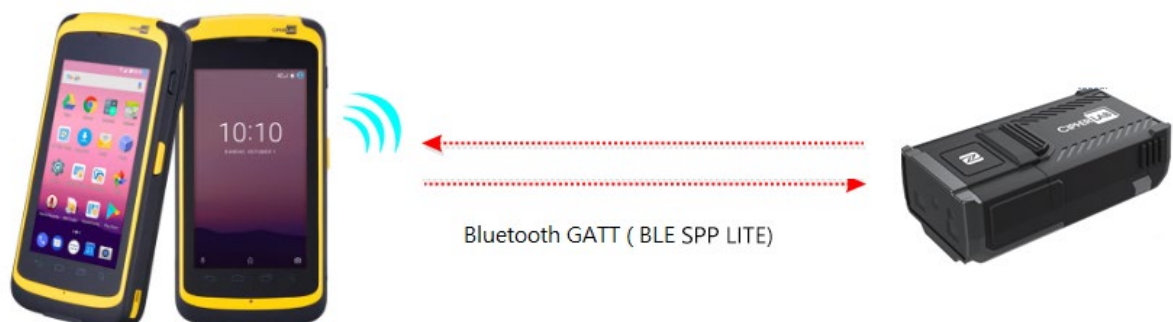

Interface	Reference
Bluetooth (BLE SPP LITE)	2.2 BLE SPP LITE

Transmit Data to PC via Bluetooth HID ...



Interface	Reference
Bluetooth HID (BLE HOGP)	2.1 BT HID

Transmit Data to PC via WR30 Dongle ...



Interface	Reference
Remote USB HID	2.5 Connect USB HID VIA WR30 Dongle
Remote USB VCOM_CDC	2.6 Connect USB VCOM_CDC VIA WR30 Dongle

IN THIS CHAPTER

3.1 Connect to THE HID of Mobile Computer via Bluetooth.....	94
3.2 Connect to BLE SPP LITE of the Mobile Computer via Bluetooth	97
3.3 Connect to BT HID of PC via Bluetooth Dongle.....	100
3.4 Enter PIN Code for Authentication	104
3.5 Connect to PC via WR30 Dongle.....	106
3.6 Connect to PC via WR30 Dongle(RS232)	108



3.1 CONNECT TO THE HID OF MOBILE COMPUTER VIA BLUETOOTH

3.1.1 CHANGE INTERFACE

To establish a bluetooth connection with the mobile computer for your ring scanner, please follow the procedures listed below to complete the required connection settings :

- 1) To enter the configuration mode, please have your ring scanner read the "Enter Setup" setup barcode.
- 2) Have your ring scanner read the setup barcode of the desired interface —
 - ▶ Activate BT HID (HOGP) & Select Keyboard Type setup barcode (Refer to [Section 2.1.1 Activate BT HID & Select Keyboard Type](#)).
- 3) Have your ring scanner read the setup barcode of WPAN connection, such as the detection mode, bluetooth pairing, PIN code, and so on.
- 4) Finally, read the "Update" setup barcode to exit the configuration mode.
- 5) Within the specified period of time (default is 2 mins) of the connectable state, the ring scanner must establish a bluetooth connection with PC or the mobile computer. At this time, the CPU is at the full speed and the LED rapidly flashes in blue color (On/Off ratio 0.5 s: 0.5 s). Refer to Sections [1.1.2 Power Economy](#) and [1.1.3 Power Economy vs. WPAN Connection](#).

Once the ring scanner is out of the effective transmission range, it will response with three short beeps (high-low tone) while the connection is successfully established.

3.1.2 BUILD A CONNECTION WITH THE MOBILE COMPUTER VIA BLUETOOTH



Generally speaking, the connection will be established successfully merely by turning on the bluetooth function of the mobile computer and pairing it with the ring scanner. The process of the pairing and connection may vary slightly upon different operating systems.

Procedures of BT HID Connection

By default, the ring scanner uses BT HID and the keyboard type is configured as PCAT (US). If you choose to use BLE SPP LITE and need to switch it back to BT HID later, you must reset to use BT HID and select PCAT (US) or other country's keyboard as the keyboard type.

Refer to the following step-by-step instructions for BT HID pairing and connection. In the following instance, we take RK95 mobile computer for example to demonstrate how to establish a bluetooth connection between the ring scanner and the mobile computer.



STEP 1. Enable the bluetooth function of the mobile computer by accessing  **Settings** |  **Connected devices**, and search for the ring scanner device to be connected by tapping on **Pair new device** function.

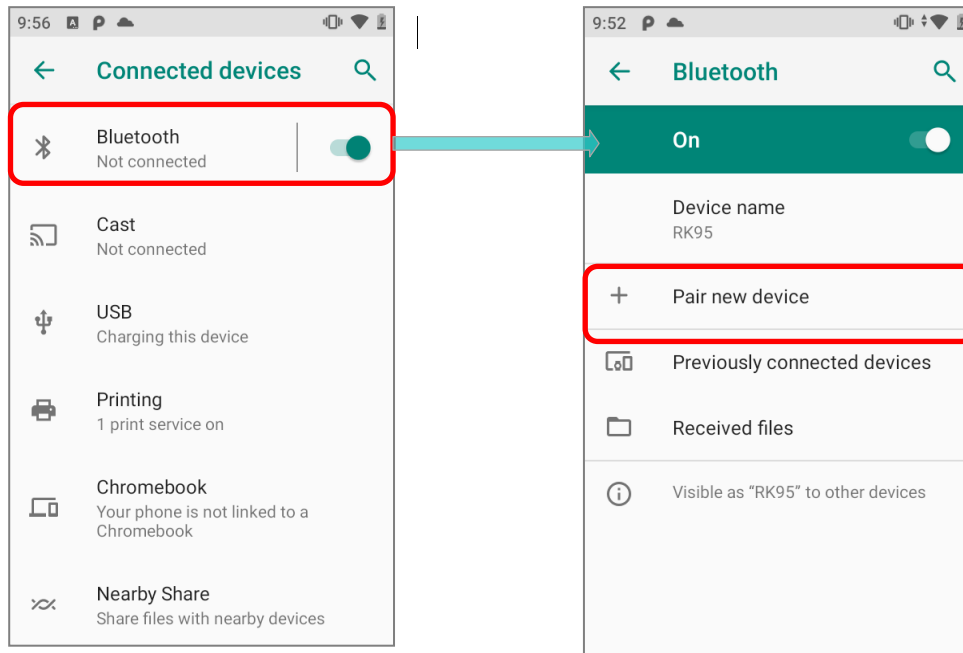

STEP 2. Tap on the searched ring scanner device to be paired, and then you will see a dialog prompt for confirmation. Tap **PAIR** to perform the bluetooth pairing.

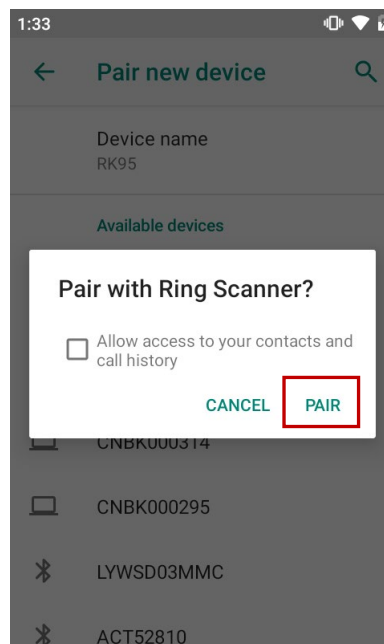

STEP 3. Check that whether the device status of this ring scanner is connected or not after the successful pairing.

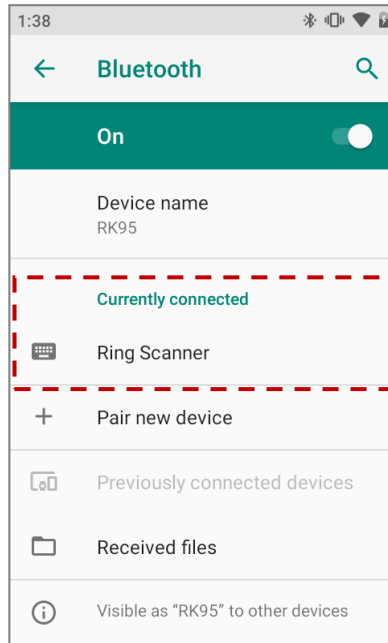

STEP 4. Now, you are able to scan the barcode and begin sending the data.

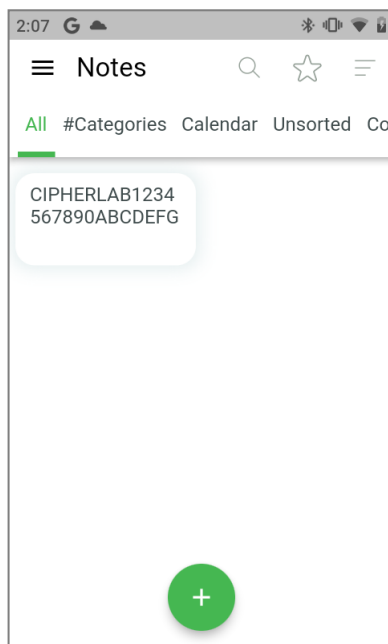

3.2 CONNECT TO BLE SPP LITE OF THE MOBILE COMPUTER VIA BLUETOOTH

3.2.1 CHANGE INTERFACE

Also follow the procedures listed below to complete the required connection settings for the ring scanner's connection with BLE SPP LITE of the mobile computer via Bluetooth.

- 1) To enter the configuration mode, please have your ring scanner read the "Enter Setup" setup barcode.
- 2) Have your ring scanner read the setup barcode of the desired interface —
 - Activate BLE SPP LITE
- 3) Have your ring scanner read the setup barcode of WPAN connection, such as the detection mode, bluetooth pairing, PIN code, and so on.
- 4) Finally, read the "Update" setup barcode to exit the configuration mode.
- 5) Within the specified period of time (default is 2 mins) of the connectable state, the ring scanner must establish a bluetooth connection with PC or the mobile computer. At this time, the CPU is at the full speed and the LED rapidly flashes in blue color (On/Off ratio 0.5 s: 0.5 s). Refer to Sections [1.1.2 Power Economy](#) and [1.1.3 Power Economy vs. WPAN Connection](#).

Once the ring scanner is out of the effective transmission range, it will response with three short beeps (high-low tone) while the connection is successfully established.

3.2.2 SCAN QR CODE TO CONNECT WITH A MOBILE COMPUTER VIA BLUETOOTH

Install the **Intelliworker** App provided by CipherLab on the mobile computer beforehand. Launch this app and have the ring scanner read the dedicated QR Code "Scan to Pair" in order to establish the bluetooth connection between the ring scanner and PC or a mobile computer.

Procedures of BLE SPP LITE Connection

By default, the ring scanner uses BT HID and the keyboard type is configured as PCAT (US). If you choose to use BLE SPP LITE and need to switch it back to BT HID later, you must reset to use BT HID and select PCAT (US) or other country's keyboard as the keyboard type.

To switch from BLE SPP LITE back to BT HID pairing and connection, refer to [Section 3.1.1 "Change Interface"](#) for the details.

A random eight-code alphanumeric characters (0-9, A-Z) will be generated by **Intelliworker** App. After having your ring scanner read the dedicated "Scan to Pair" QR Code of this App, the bluetooth device name belonging to this ring scanner will be changed as the one (e.g. X8YIQBPG) specified by the QR Code. The mobile computer will actively search for the scanner named "X8YIQBPG", and establish a bluetooth connection with this ring scanner.

For Example, #@NAME=X8YIQBPG



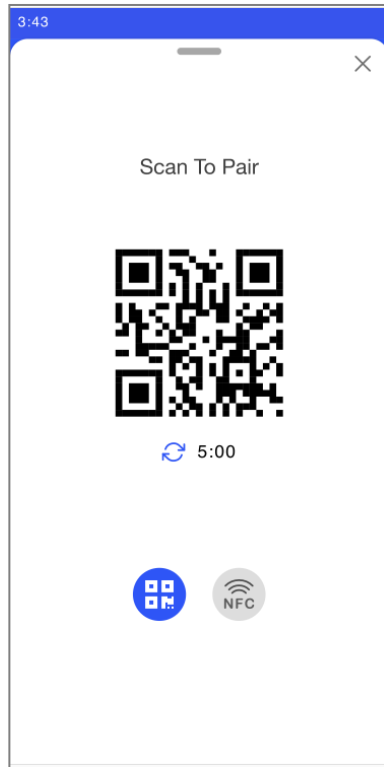

To reset WR30 ring scanner back to the default device name and disconnect the connection between the ring scanner and the mobile computer, please press the **Disconnect** button on the start-up screen of **Intelliworker** App before scanning the [Restore System Defaults](#) barcode.

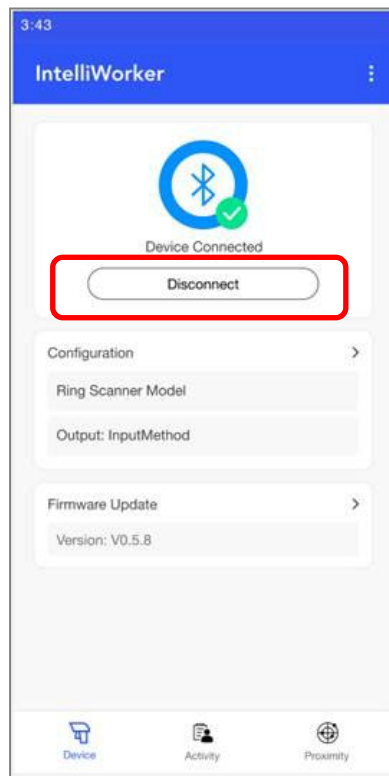

3.2.3 BUILD A BLUETOOTH CONNECTION WITH THE MOBILE COMPUTER THROUGH NFC

Launch **CipherLab Intelliworker** App installed on the mobile computer, and enable the bluetooth as well as NFC sensing functions of the mobile computer. Through the "Tap To Pair" screen of the **Intelliworker** App on the mobile computer, the scanner will pair with the mobile computer and successfully establish the bluetooth connection between them.

Procedures of BLE SPP LITE Pairing and Connection through NFC

STEP 1. Enable both the bluetooth and NFC functions of the mobile computer.

STEP 2. Now, place the bottom of the ring scanner close to the "Tap To Pair" screen of the **Intelliworker** App within 1 cm. The ring scanner will respond with one beep and its connection status will be changed into "Device Connected" in case the bluetooth connection is established successfully.

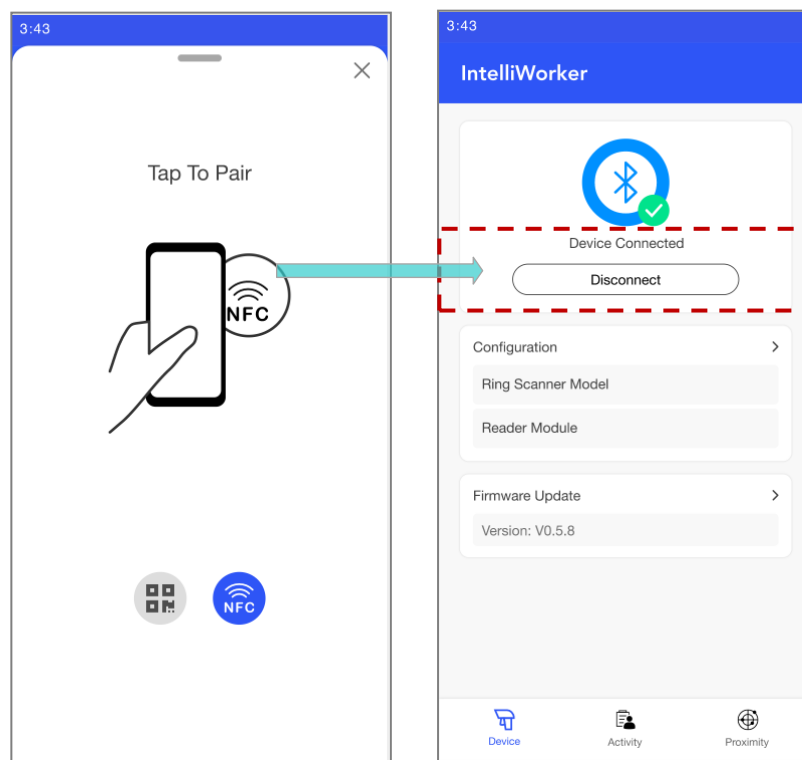

3.3 CONNECT TO BT HID OF PC VIA BLUETOOTH DONGLE

3.3.1 CHANGE INTERFACE

To establish a bluetooth connection with the computer for your ring scanner, please follow the procedures listed below to complete the required connection settings :

- 1) To enter the configuration mode, please have your ring scanner read the "Enter Setup" setup barcode.
- 2) Have your ring scanner read the setup barcode of the desired interface —
 - Activate BT HID (HOGP) & Select Keyboard Type setup barcode (Refer to [Section 2.1.1 Activate BT HID & Select Keyboard Type](#)).
- 3) Have your ring scanner read the setup barcode of WPAN connection, such as the detection mode, bluetooth pairing, PIN code, and so on.
- 4) Finally, read the "Update" setup barcode to exit the configuration mode.
- 5) Within the specified period of time (default is 2 mins) of the connectable state, the ring scanner must establish a bluetooth connection with PC or the mobile computer. At this time, the CPU is at the full speed and the LED rapidly flashes in blue color (On/Off ratio 0.5 s: 0.5 s). Refer to Sections [1.1.2 Power Economy](#) and [1.1.3 Power Economy vs. WPAN Connection](#).

Once the ring scanner is out of the effective transmission range, it will response with three short beeps (high-low tone) while the connection is successfully established.



3.3.2 BUILD A CONNECTION USING BLUETOOTH DONGLE

Generally speaking, just follow the instructions provided by the wizard of PC, a bluetooth connection between the ring scanner and PC can be established successfully after the pairing. The process of the pairing and connection may vary slightly upon the application you use.

If the operation system of your PC is Microsoft® Windows® 10, you can proceed the pairing and connection by adding a new bluetooth device through the built-in wizard. You can use the application provided by the manufacturer of bluetooth dongles as well.

Procedures of BT HID Connection

By default, the ring scanner uses BT HID and the keyboard type is configured as PCAT (US). If you choose to use BLE SPP LITE and need to switch it back to BT HID later, you must reset to use BT HID and select PCAT (US) or other country's keyboard as the keyboard type.

For BT HID pairing and connection, refer to the step-by-step instructions listed below. In the following instance, we take Windows 10 operation system for example to demonstrate how to establish a bluetooth connection between PC and the ring scanner.

STEP 1. Go to **Start→Setup→Device**, and then the "Bluetooth & other devices" window will appear(see the figure below). Enable the bluetooth function and click  button to add a new bluetooth device.

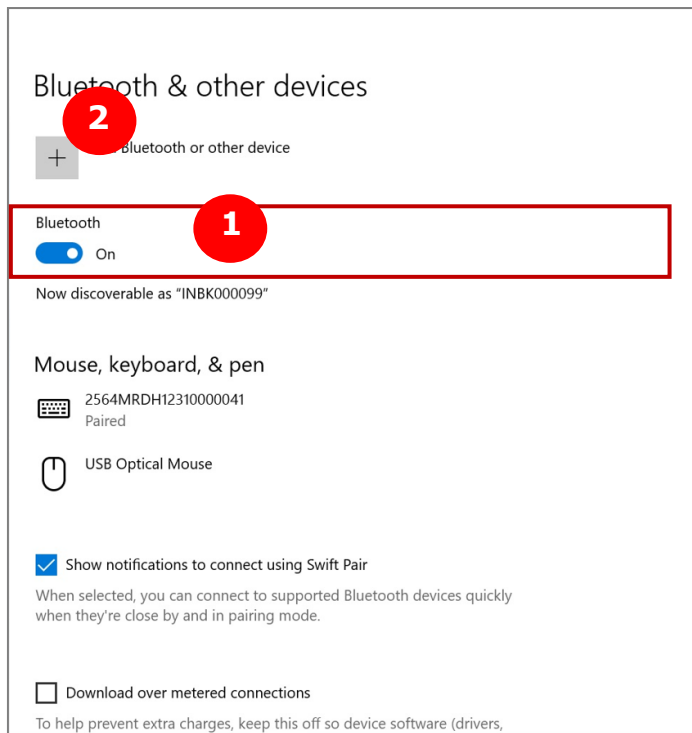

STEP 2. Then, a pop-up window as the figure below will be shown. PC will start to search for the surrounding bluetooth device(s) when selecting **Bluetooth** option.

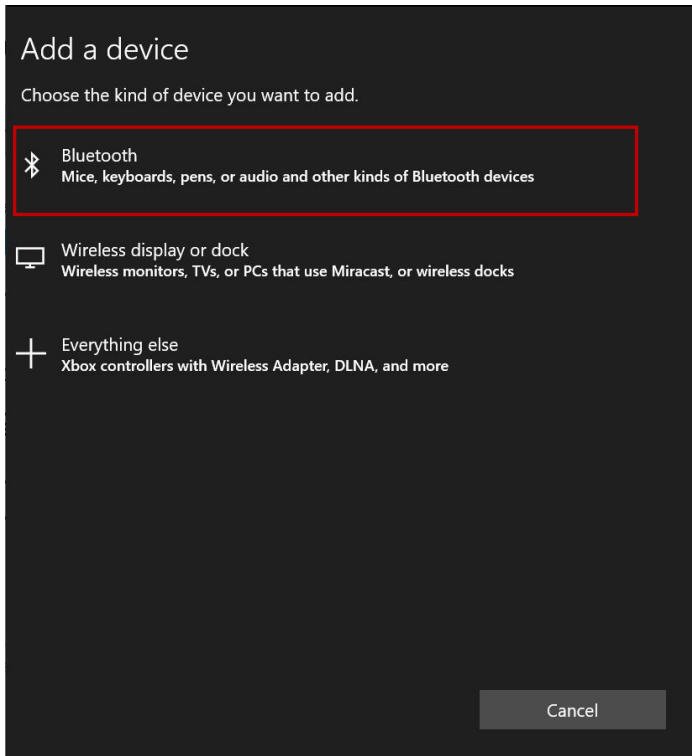

STEP 3. Click on the searched Ring Scanner to be paired.

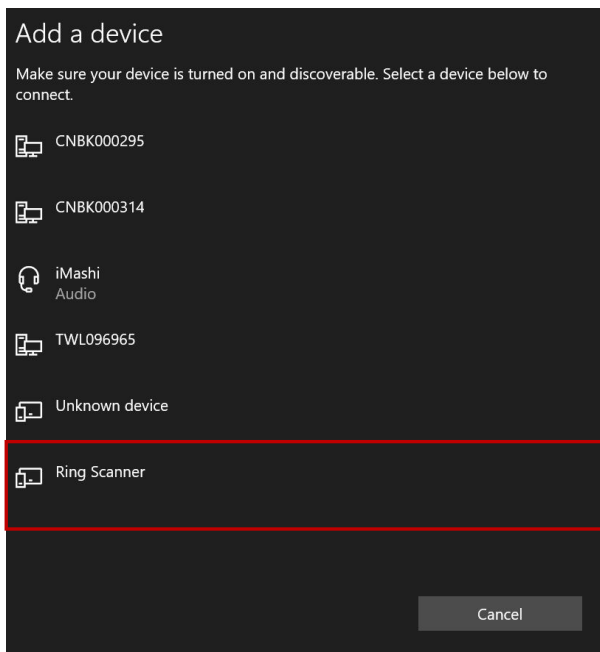

STEP 4. A message of “Your device is ready to go” will be shown if PC pairs with the ring scanner and the bluetooth connection is established successfully.

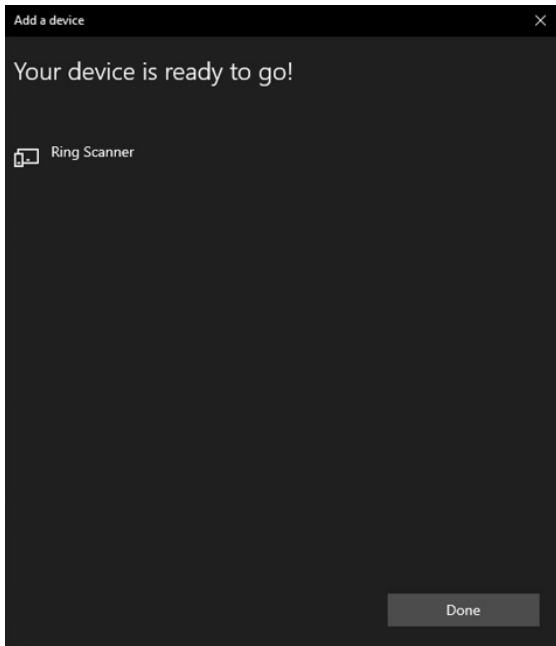

STEP 5. The device status of ring scanner will show “Connected” after the bluetooth connection is established successfully. And the scanner is ready to scan the barcode and send the data.

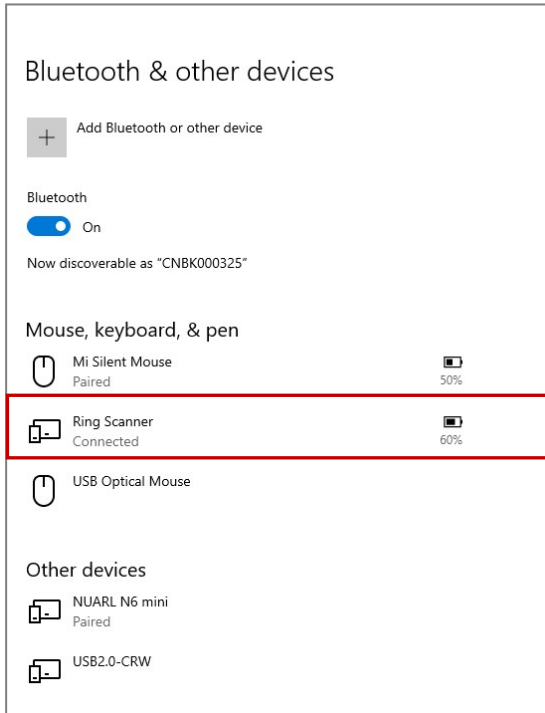

3.4 ENTER PIN CODE FOR AUTHENTICATION

3.4.1 USE JUST WORKS

- 1) In the configuration mode, read the "Use Just Works" barcode below.

*Use Just Works



- 2) Configure the scanner as Just Works mode, and begin to search for the scanner on PC or the mobile phone. Click on this searched scanner, PC or the mobile phone will automatically pair with it without entering a PIN code.

3.4.2 USE PRESET PIN

- 1) In the configuration mode, read the barcode below to use a preset PIN for authentication.

Use Preset PIN



- 2) Read the barcode below to specify the PIN code, in decimal.
By default, the PIN code is set to "000000". Only 6-digit fixed length is allowed.

Enter PIN in
Decimal...



- 3) On Appendix IV, read the "Decimal Value" barcode for the desired digits.
Read the "Clear PIN Code" barcode first if you need to re-input the PIN code.

Clear PIN Code



- 4) Read the "Validate" barcode on Appendix IV to complete this setting.

Note: WR30 Preset PIN only supports Windows 10 and iOS operation system. It is recommend to choose Just Works or Random to proceed with the pairing with Android mobile computer or mobile phone.



3.4.3 USE RANDOM PIN

In the configuration mode, read the barcode below to use a random PIN for authentication.

use random PIN



Note: When using BT HID, some device driver may not support pre-defined PIN code for authentication. In this case, make sure you have the scanner set to "use random PIN" before pairing. While pairing, the host PIN code will be displayed on the computer screen.

Use Random PIN

When the target device is set to use a random PIN for authentication, wait until the random PIN is displayed on the target device while pairing, and then input the matching PIN code on the scanner.

Note: Follow the steps below to enter the matching PIN on the scanner. There is no need to enter the configuration mode!

1. Read the barcode below to specify the PIN code, in decimal.

Enter PIN in
Decimal...



2. On Appendix IV, read the "Decimal Value" barcode for the desired digits.
Read the "Clear PIN Code" barcode first if you need to re-input the PIN.

Clear PIN Code



3. Read the "Validate" barcode on Appendix IV to complete this setting.

Reject Random PIN Request

When the random PIN is displayed on the target device while pairing, you can reject the PIN request by having the scanner read the "Validate" barcode.

3.4.4 USE OOB (OUT OF BANK) THROUGH NFC

With the built-in OOB pairing mode, and the ring scanner requires no additional settings.

- ▶ Enable the bluetooth and NFC sensing functions of the Android mobile device equipped with OOB pairing capability, and then place the Android mobile device close to the NFC antenna of the ring scanner. The bluetooth connection and pairing will be established automatically.



3.5 CONNECT TO PC VIA WR30 DONGLE

By default, the interface of WR30 Dongle is set to "USB HID". Please connect WR30 Dongle to the USB port of PC.

Note: WR30 Dongle only supports Windows 10 operating system or above.

3.5.1 CONNECT TO WR30 DONGLE

By scanning the setting barcode

Connect the ring scanner to WR30 Dongle by reading the setup barcode label in the back of WR30 Dongle. The scanner will rapidly build a connection with WR30 Dongle.

- ▶ CrAdLeXXXXXXXXXXXX
- ▶ The format of CrAdLe setting barcode can be supported: 2D (Data Matrix)

Read the setting barcode (XXXXXXXXXXXX stands for the MAC address of WR30 Dongle). The scanner will respond with one beep to indicate that the reading of this barcode is successful, the scanner will stay active for a specified period of time (2 minutes by default) trying to connect to WR30 Dongle while its LED is flashing blue (On/Off ratio 0.5 s: 0.5 s).

Once connected, the scanner will respond with three beeps (tone ascending from low to high), and the LED flashes blue (On/Off ratio 0.02 s: 3 s). When the ring scanner is out of the effective transmission range, the scanner will respond with three short beeps (tone descending from high to low).

To obtain the MAC address of WR30 Dongle, the usage is as follows:

If the setup barcode label on WR30 Dongle is illegible or missing, the users can obtain the MAC address of this dongle by pressing the button on it for around 3 seconds in order to produce a single 2D setup barcode.



3.5.2 CHANGE WR30 DONGLE INTERFACE

If you would like to change the interface of WR30 Dongle, use one of the scanners to configure the interface-related settings and it will pass the new settings to WR30 Dongle, which will then initialize and pass the settings to any other connected scanners.

- 1) Have all scanners read the "Set Connection" and "Serial Number" labels of WR30 Dongle.
- 2) Connect WR30 Dongle to the USB port of PC. (Note: WR30 Dongle only supports Windows 10 operating system or above).
- 3) The scanners will connect to your computer via WR30 Dongle.
- 4) Have one scanner read the "Enter Setup" setup barcode to enter the configuration mode.
- 5) Have this scanner read the desired interface barcode and configure its related settings –
 - ▶ Activate Remote USB HID & Select Keyboard Type setup barcode (Refer to [Section 2.6.1 Activate USB HID & Select Keyboard Type](#)).
 - ▶ Activate Remote USB VCOM_CDC setup barcode (Refer to [Section 2.7.1 Activate USB VCOM_CDC](#)).
- 6) Have this scanner read the "Update" setup barcode to exit the configuration mode.
- 7) After this scanner resumes connection with WR30 Dongle, it will pass the interface-related settings to WR30 Dongle.
- 8) Upon receipt of the new settings, WR30 Dongle will initialize itself.
- 9) Updated with new settings, WR30 Dongle will pass these settings to other connected scanners.

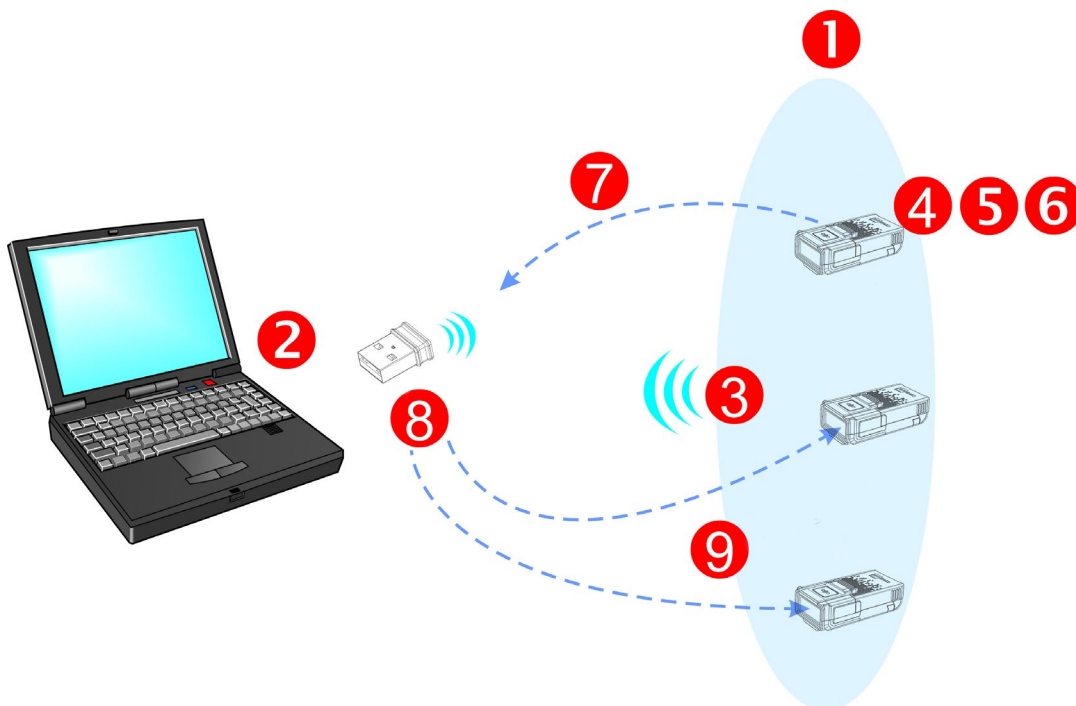

3.6 CONNECT TO PC VIA WR30 DONGLE(RS232)

The interface of WR30 Dongle RS232 is set to "RS232". Please connect WR30 Dongle RS232 to the serial port of PC.

3.6.1 CONNECT TO WR30 DONGLE (RS232)

By scanning the setting barcode

Connect the ring scanner to WR30 Dongle RS232 by reading the setup barcode label in the back of WR30 Dongle RS232. The scanner will rapidly build a connection with WR30 Dongle RS232.

- ▶ SeTcOnXXXXXXXXXXXX
- ▶ The format of SeTcOn setting barcode can be supported: 2D (QR Code)

Read this setting barcode (XXXXXXXXXXXX stands for the MAC address of WR30 Dongle RS232). The scanner will respond with one beep to indicate that the reading of this barcode is successful, the scanner will stay active for a specified period of time (2 minutes by default) trying to connect to WR30 Dongle RS232 while its LED is flashing blue (On/Off ratio 0.5 s: 0.5 s).

Once connected, the scanner will respond with three beeps (tone ascending from low to high), and the LED flashes blue (On/Off ratio 0.02 s: 3 s). When the ring scanner is out of the effective transmission range, the scanner will respond with three short beeps (tone descending from high to low). A WR30 Dongle RS232 only can simultaneously connect with a set of ring scanner.



CHANGING SYMBOLOGY SETTINGS

In this chapter, a brief on the symbology settings is provided for your reference.

IN THIS CHAPTER

4.1 Codabar.....	110
4.2 Code 25 – Industrial 25	112
4.3 Code 25 – Interleaved 25.....	113
4.4 Code 25 – Matrix 25.....	115
4.5 Code 25 – Chinese 25.....	117
4.6 Italian Pharmacode (Code 32)	117
4.7 Code 39.....	117
4.8 Trioptic Code 39	120
4.9 Code 93.....	120
4.10 Code 128	122
4.11 GS1-128 (EAN-128)	122
4.12 ISBT 128.....	124
4.13 GS1 DataBar (RSS Family)	126
4.14 MSI	132
4.15 EAN-8.....	134
4.16 EAN-13	135
4.17 UCC Coupon Extended Code	139
4.18 UPC-A.....	139
4.19 UPC-E	141
4.20 Code 11	144
4.21 Composite Code	146
4.22 US Postal Code	149
4.23 UK Postal Code	150
4.24 More Postal Code	150
4.25 2D Symbologies.....	152
4.26 Macro PDF.....	157



4.1 CODABAR

Decide whether to decode Codabar.

***Enable**



100313

Disable



100312

4.1.1 START/STOP TRANSMISSION

Decide whether to include the start/stop characters in the data being transmitted.

**Transmit
Start/Stop
Characters**



100441

***Do Not Transmit**



100440

4.1.2 CLSI CONVERSION

When enabled, the CLSI editing strips the start/stop characters and inserts a space after the first, fifth, and tenth characters of a 14-character Codabar barcode.

Apply CLSI Editing



100443

***Do Not Apply**



100442

Note: The 14-character barcode length does not include start/stop characters.

4.1.3 CODE LENGTH QUALIFICATION

To prevent the "short scan" error, define the "Length Qualification" settings to ensure that the correct barcode is read by qualifying the allowable code length.



- ▶ If "Max./Min. Length" is selected, the maximum length and the minimum length must be specified. It only accepts those barcodes with lengths that fall between max/min lengths specified.
- ▶ If "Fixed Length" is selected, up to 2 fixed lengths can be specified.

Note: The specified length(s) must include the check digit(s) the barcode contains.

- 1) Read the barcode to enable either Max. /Min. Length qualification or Fixed Length(s) qualification.

***Enable Max./Min.
Length (1~55)...**



102222

**Enable Fixed
Length(s)...**



102221

- 2) Read the barcode for Max. Length or Fixed Length 1, and follow steps 3~4.
Repeat steps 2~4 for Min. Length or Fixed Length 2.

**Max. Length (*55)
or Fixed Length 1**



102223

**Min. Length (*4)
or Fixed Length 2**



102224

- 3) Read the "Decimal Value" barcode on Appendix IV for the desired length.
- 4) Read the "Validate" barcode on Appendix IV to complete this setting.



4.2 CODE 25 – INDUSTRIAL 25

Decide whether to decode Industrial 25.

***Enable**



Disable



4.2.1 CODE LENGTH QUALIFICATION

To prevent the "short scan" error, define the "Length Qualification" settings to ensure that the correct barcode is read by qualifying the allowable code length.

- ▶ If "Max/Min Length" is selected, the maximum length and the minimum length must be specified. It only accepts those barcodes with lengths that fall between max/min lengths specified.
- ▶ If "Fixed Length" is selected, up to 2 fixed lengths can be specified.

Note: The specified length(s) must include the check digit(s) the barcode contains.

- 1) Read the barcode to enable either Max. /Min. Length qualification or Fixed Length(s) qualification.

***Enable Max./Min.
Length (1~55)...**



**Enable Fixed
Length(s)...**



- 2) Read the barcode for Max. Length or Fixed Length 1, and follow steps 3~4.
Repeat steps 2~4 for Min. Length or Fixed Length 2.

**Max. Length (*55)
or Fixed Length 1**



**Min. Length (*4)
or Fixed Length 2**



- 3) Read the "Decimal Value" barcode on Appendix IV for the desired length.
- 4) Read the "Validate" barcode on Appendix IV to complete this setting.



4.3 CODE 25 – INTERLEAVED 25

Decide whether to decode Interleaved 25.

***Enable**



Disable



4.3.1 VERIFY CHECK DIGIT

Decide whether to verify the check digit. When desired, select one of the algorithms, USS or OPCC. If incorrect, the barcode will not be accepted.

***Do Not Verify**



USS Check Digit



OPCC Check Digit



4.3.2 TRANSMIT CHECK DIGIT

Decide whether to include the check digit in the data being transmitted.

***Transmit
Interleaved 25
Check Digit**



Do Not Transmit



4.3.3 CONVERT TO EAN-13

Decide whether to convert a 14-character barcode into EAN-13 if the following requirements are met:

- ▶ The barcode must have a leading 0 and a valid EAN-13 check digit.



- ▶ "Verify Check Digit" must be disabled.

Convert to EAN-13



*Do Not Convert



4.3.4 CODE LENGTH QUALIFICATION

To prevent the "short scan" error, define the "Length Qualification" settings to ensure that the correct barcode is read by qualifying the allowable code length.

- ▶ If "Max/Min Length" is selected, the maximum length and the minimum length must be specified. It only accepts those barcodes with lengths that fall between max/min lengths specified.
- ▶ If "Fixed Length" is selected, up to 2 fixed lengths can be specified.

Note: The specified length(s) must include the check digit(s) the barcode contains.

- 1) Read the barcode to enable either Max. /Min. Length qualification or Fixed Length(s) qualification.

*Enable Max./Min.
Length (1~55)...



Enable Fixed
Length(s)...



- 2) Read the barcode for Max. Length or Fixed Length 1, and follow steps 3~4.
Repeat steps 2~4 for Min. Length or Fixed Length 2.

Max. Length (*55)
or Fixed Length 1



Min. Length (*4)
or Fixed Length 2



- 3) Read the "Decimal Value" barcode on Appendix IV for the desired length.
- 4) Read the "Validate" barcode on Appendix IV to complete this setting.



4.4 CODE 25 – MATRIX 25

Decide whether to decode Matrix 25.

Enable



*Disable



4.4.1 VERIFY CHECK DIGIT

Decide whether to verify the check digit. If incorrect, the barcode will not be accepted.

Verify Matrix 25
Check Digit



*Do Not Verify



4.4.2 TRANSMIT CHECK DIGIT

Decide whether to include the check digit in the data being transmitted.

*Transmit Matrix
25 Check Digit



Do Not Transmit



4.4.3 CODE LENGTH QUALIFICATION

To prevent the "short scan" error, define the "Length Qualification" settings to ensure that the correct barcode is read by qualifying the allowable code length.

- ▶ If "Max/Min Length" is selected, the maximum length and the minimum length must be specified. It only accepts those barcodes with lengths that fall between max/min lengths specified.
- ▶ If "Fixed Length" is selected, up to 2 fixed lengths can be specified.

Note: The specified length(s) must include the check digit(s) the barcode contains.

- 1) Read the barcode to enable either Max. /Min. Length qualification or Fixed Length(s) qualification.



***Enable Max./Min.
Length (1~55)...**



100609

**Enable Fixed
Length(s)...**



100608

- 2) Read the barcode for Max. Length or Fixed Length 1, and follow steps 3~4.
Repeat steps 2~4 for Min. Length or Fixed Length 2.

**Max. Length (*55)
or Fixed Length 1**



100610

**Min. Length (*4)
or Fixed Length 2**



100611

- 3) Read the "Decimal Value" barcode on Appendix IV for the desired length.
- 4) Read the "Validate" barcode on Appendix IV to complete this setting.



4.5 CODE 25 – CHINESE 25

Decide whether to decode Chinese 25.

Enable



*Disable



4.6 ITALIAN PHARMACODE (CODE 32)

Decide whether to decode Italian Pharmacode.

Enable



*Disable



Note: Code 39 must be enabled first.

4.7 CODE 39

Decide whether to decode Code 39.

*Enable



Disable



4.7.1 VERIFY CHECK DIGIT

Decide whether to verify the check digit. If incorrect, the barcode will not be accepted.



Verify Code 39
Check Digit



100405

*Do Not Verify



100404

4.7.2 TRANSMIT CHECK DIGIT

Decide whether to include the check digit in the data being transmitted.

*Transmit Code 39
Check Digit



100407

Do Not Transmit



100406

4.7.3 STANDARD/FULL ASCII CODE 39

Decide whether to support Code 39 Full ASCII that includes all the alphanumeric and special characters.

Code 39 Full ASCII



100401

*Standard Code 39



100400

Note: Trioptic Code 39 and Code 39 Full ASCII cannot be enabled at the same time.



4.7.4 CODE LENGTH QUALIFICATION

To prevent the "short scan" error, define the "Length Qualification" settings to ensure that the correct barcode is read by qualifying the allowable code length.

- ▶ If "Max/Min Length" is selected, the maximum length and the minimum length must be specified. It only accepts those barcodes with lengths that fall between max/min lengths specified.
- ▶ If "Fixed Length" is selected, up to 2 fixed lengths can be specified.

Note: The specified length(s) must include the check digit(s) the barcode contains.

- 1) Read the barcode to enable either Max. /Min. Length qualification or Fixed Length(s) qualification.

***Enable Max./Min.
Length (1~55)...**



**Enable Fixed
Length(s)...**



- 2) Read the barcode for Max. Length or Fixed Length 1, and follow steps 3~4.
Repeat steps 2~4 for Min. Length or Fixed Length 2.

**Max. Length (*55)
or Fixed Length 1**



**Min. Length (*4)
or Fixed Length 2**



- 3) Read the "Decimal Value" barcode on Appendix IV for the desired length.
- 4) Read the "Validate" barcode on Appendix IV to complete this setting.



4.8 TRIOPTIC CODE 39

Decide whether to decode Trioptic Code 39.

- ▶ Trioptic Code 39 is a variant of Code 39 used in the marking of computer tap cartridges. It always contains six characters.

Enable



*Disable



Note: Trioptic Code 39 and Code 39 Full ASCII cannot be enabled at the same time.

4.9 CODE 93

Decide whether to decode Code 93.

*Enable



Disable



4.9.1 CODE LENGTH QUALIFICATION

To prevent the "short scan" error, define the "Length Qualification" settings to ensure that the correct barcode is read by qualifying the allowable code length.

- ▶ If "Max/Min Length" is selected, the maximum length and the minimum length must be specified. It only accepts those barcodes with lengths that fall between max/min lengths specified.
- ▶ If "Fixed Length" is selected, up to 2 fixed lengths can be specified.

Note: The specified length(s) must include the check digit(s) the barcode contains.

- 1) Read the barcode to enable either Max. /Min. Length qualification or Fixed Length(s) qualification.



***Enable Max./Min.
Length (1~55)...**



102226

**Enable Fixed
Length(s)...**



102225

- 2) Read the barcode for Max. Length or Fixed Length 1, and follow steps 3~4.
Repeat steps 2~4 for Min. Length or Fixed Length 2.

**Max. Length (*55)
or Fixed Length 1**



102227

**Min. Length (*4)
or Fixed Length 2**



102228

- 3) Read the "Decimal Value" barcode on Appendix IV for the desired length.
- 4) Read the "Validate" barcode on Appendix IV to complete this setting.



4.10 CODE 128

Decide whether to decode Code 128.

***Enable**



Disable



4.11 GS1-128 (EAN-128)

Decide whether to decode GS1-128.

***Enable**



Disable



Note: GS1-128 barcodes can be decoded only when this setting is enabled.

4.11.1 TRANSMIT CODE ID

Decide whether to include the Code ID ("`␣01`") in the data being transmitted.

**Transmit GS1-128
Code ID**



***Do Not Transmit**



4.11.2 FIELD SEPARATOR (GS CHARACTER)

Decide whether to apply a field separator (to convert the `␣01` control character to human readable character).



Enable Field Separator...



- 1) Read the barcode above to enable field separator.
- 2) Read the "[Hexadecimal Value](#)" barcode on Appendix IV for the desired character string.
- 3) Read the "Validate" barcode on Appendix IV to complete this setting.

Note: GS1-128 barcodes start with the [FNC1](#) control character to distinguish themselves from other uses of Code 128. [FNC1](#) is also used to separate data fields in the GS1-128 barcodes.

4.11.3 GS1 FORMATTING

Decide whether to enable GS1 formatting for GS1-128. When enabled, code ID transmitting will be disabled; however, the field separator and application ID mark characters will be automatically added to the output data.

Enable GS1 Formatting



*Disable GS1 Formatting



You may want to add an application ID mark (1 character long) to the left (AIMark1) or right (AIMark2) of an application ID (AI) for the purpose of labeling it when formatting the GS1 data.

AIMark1



AIMark2



- 1) Read the barcode above to add a mark to the left (AIMark1)/right (AIMark2) of an application ID.
- 2) Read the "[Hexadecimal Value](#)" barcode on Appendix IV for the desired character. Read '00' if you want to remove the AI mark.
- 3) Read the "Validate" barcode on Appendix IV to complete this setting.



4.12 ISBT 128

Decide whether to decode ISBT 128.

***Enable**



Disable



4.12.1 ISBT CONCATENATION

Decide whether to decode and concatenate pairs of ISBT barcodes.

▶ **Disable ISBT Concatenation**

It will not concatenate pairs of ISBT barcodes it encounters.

▶ **Enable ISBT Concatenation**

There must be two ISBT barcodes in order for the scanner to decode and perform concatenation. It does not decode single ISBT barcodes.

▶ **Auto-discriminate ISBT Concatenation**

It decodes and concatenates pairs of ISBT barcodes immediately. If only a single ISBT barcode is present, the scanner must decode 10 times before transmitting its data to confirm that there is no additional ISBT barcode.

Disable



Enable



***Auto-discriminate**



4.12.2 ISBT CONCATENATION REDUNDANCY

Specify the concatenation redundancy (2~20 times) when ISBT concatenation is enabled.

ISBT
Concatenation
Redundancy 2~20
(*10)



- 1) Read the barcode above to specify the concatenation redundancy.
- 2) Read the "Decimal Value" barcode on Appendix IV for the desired redundancy.
- 3) Read the "Validate" barcode on Appendix IV to complete this setting.



4.13 GS1 DATABAR (RSS FAMILY)

It is categorized into three groups:

Group I – GS1 DataBar Omnidirectional (RSS-14)

This group consists of the following:

- ▶ GS1 DataBar Omnidirectional
- ▶ GS1 DataBar Truncated
- ▶ GS1 DataBar Stacked
- ▶ GS1 DataBar Stacked Omnidirectional

Group II – GS1 DataBar Expanded (RSS Expanded)

This group consists of the following:

- ▶ GS1 DataBar Expanded
- ▶ GS1 DataBar Expanded Stacked

Group III – GS1 DataBar Limited (RSS Limited)

This group consists of the following:

- ▶ GS1 DataBar Limited

4.13.1 SELECT CODE ID

Select a desired Code ID to use:

- ▶ "je0" (GS1 DataBar Code ID)
- ▶ "jc1" (GS1-128 Code ID)

Use "jc1"



*Use "je0"



4.13.2 GS1 DATABAR OMNIDIRECTIONAL (RSS-14)

*Enable RSS-14 &
RSS Expanded
(Groups I, II)



Disable





When GS1 formatting for GS1 DataBar Omnidirectional is enabled, code ID transmitting will be disabled; however, application ID transmitting will be enabled automatically. The settings below apply to Group I symbologies only:

- ▶ GS1 DataBar Omnidirectional
- ▶ GS1 DataBar Truncated
- ▶ GS1 DataBar Stacked
- ▶ GS1 DataBar Stacked Omnidirectional



Transmit Code ID

Decide whether to include the Code ID in the data being transmitted.

<p>Transmit RSS-14 Code ID</p>	 100523
<p>*Do Not Transmit</p>	 100522



Transmit Application ID

Decide whether to include the Application ID ("01") in the data being transmitted.

<p>*Transmit RSS-14 Application ID</p>	 100529
<p>Do Not Transmit</p>	 100528

GS1 Formatting for GS1 DataBar Omnidirectional

Decide whether to enable GS1 formatting for GS1 DataBar Omnidirectional. When enabled, the field separator and application ID mark characters will be automatically added to the output data.

<p>Enable GS1 Formatting</p>	 101486
<p>*Disable GS1 Formatting</p>	 101485



4.13.3 GS1 DATABAR EXPANDED (RSS EXPANDED)

***Enable RSS-14 &
RSS Expanded
(Groups I, II)**



100349

Disable



100348

When GS1 formatting for GS1 DataBar Expanded is enabled, code ID transmitting will be disabled.

The settings below apply to Group II symbologies only:

- ▶ GS1 DataBar Expanded
- ▶ GS1 DataBar Expanded Stacked

Transmit Code ID

Decide whether to include the Code ID in the data being transmitted.

**Transmit
RSS Expanded Code
ID**



100527

***Do Not Transmit**



100526

GS1 Formatting for GS1 DataBar Expanded

Decide whether to enable GS1 formatting for GS1 DataBar Expanded. When enabled, the field separator and application ID mark characters will be automatically added to the output data.

**Enable GS1
Formatting**



101490

***Disable GS1
Formatting**



101489

4.13.4 GS1 DATABAR LIMITED (RSS LIMITED)

***Enable RSS
Limited
(Group III)**



100351



Disable



100350

When GS1 formatting for GS1 DataBar Limited is enabled, code ID transmitting will be disabled; however, application ID transmitting will be enabled automatically.

Transmit Code ID

Decide whether to include the Code ID in the data being transmitted.

Transmit
RSS Limited Code ID



100525

*Do Not Transmit



100524

Transmit Application ID

Decide whether to include the Application ID ("01") in the data being transmitted.

*Transmit
RSS Limited
Application ID



100531

Do Not Transmit



100530

GS1 Formatting for GS1 DataBar Limited

Decide whether to enable GS1 formatting for GS1 DataBar Limited. When enabled, the field separator and application ID mark characters will be automatically added to the output data.

Enable GS1
Formatting



101488

*Disable GS1
Formatting



101487



4.13.5 CONVERT TO UPC/EAN

This only applies to GS1 DataBar Omnidirectional and GS1 DataBar Limited barcodes not decoded as part of a Composite barcode.

- ▶ Convert to EAN-13: It will strip the leading "010" from barcodes.
"01" is the Application ID and must be followed by a single zero (the first digit encoded).
- ▶ Convert to UPC-A: It will strip the leading "0100" from barcodes.
"01" is the Application ID and must be followed by two or more zeros (but not six zeros).

Convert to UPC/EAN



*Do Not Convert



4.13.6 FIELD SEPARATOR (GS CHARACTER)

Decide whether to apply a field separator (to convert the GS control character to human readable character). The field separator is automatically added to the data when GS1 formatting is enabled.

Specify Field Separator...



- 1) Read the barcode above to specify field separator.
- 2) Read the "[Hexadecimal Value](#)" barcode on page 240 for the desired character string.
- 3) Read the "Validate" barcode to complete this setting.



4.13.7 APPLICATION ID MARK

You may want to add an application ID mark (1 character long) to the left (AIMark1) or right (AIMark2) of an application ID (AI) for the purpose of labeling it when formatting the GS1 data.

AIMark1



AIMark2



- 1) Read the barcode above to add a mark to the left (AIMark1)/right (AIMark2) of an application ID.
- 2) Read the "[Hexadecimal Value](#)" barcode on Appendix IV for the desired character. Read '00' if you want to remove the AI mark.
- 3) Read the "Validate" barcode on Appendix IV to complete this setting.





4.14 MSI

Decide whether to decode MSI.

Enable	 100345
*Disable	 100344

4.14.1 VERIFY CHECK DIGIT

Select one of the three calculations to verify check digit(s) when decoding barcodes. If incorrect, the barcode will not be accepted.

*Single Modulo 10	 100448
Double Modulo 10	 100449
Modulo 10 & 11	 100450

4.14.2 TRANSMIT CHECK DIGIT

Decide whether to include the check digit(s) in the data being transmitted.

*Last Digit Not Transmitted	 100452
Both Digits Transmitted	 100453
Both Digits Not Transmitted	 100454



4.14.3 CODE LENGTH QUALIFICATION

To prevent the "short scan" error, define the "Length Qualification" settings to ensure that the correct barcode is read by qualifying the allowable code length.

- ▶ If "Max/Min Length" is selected, the maximum length and the minimum length must be specified. It only accepts those barcodes with lengths that fall between max/min lengths specified.
- ▶ If "Fixed Length" is selected, up to 2 fixed lengths can be specified.

Note: The specified length(s) must include the check digit(s) the barcode contains.

- 1) Read the barcode to enable either Max. /Min. Length qualification or Fixed Length(s) qualification.

***Enable Max./Min.
Length (1~55)...**



**Enable Fixed
Length(s)...**



- 2) Read the barcode for Max. Length or Fixed Length 1, and follow steps 3~4.
Repeat steps 2~4 for Min. Length or Fixed Length 2.

**Max. Length (*55)
or Fixed Length 1**



**Min. Length (*4)
or Fixed Length 2**



- 3) Read the "Decimal Value" barcode on Appendix IV for the desired length.
- 4) Read the "Validate" barcode on Appendix IV to complete this setting.



4.15 EAN-8

EAN-8

***Enable EAN-8
(No Addon)**



Disable



EAN-8 Addon 2

**Enable EAN-8 Addon
2**



***Disable**



EAN-8 Addon 5

**Enable EAN-8 Addon
5**



***Disable**



4.15.1 TRANSMIT CHECK DIGIT

Decide whether to include the check digit in the data being transmitted.

***Transmit EAN-8
Check Digit**



Do Not Transmit



4.16 EAN-13

EAN-13

***Enable EAN-13
(No Addon)**



Disable



Decide whether to read EAN-13 barcodes ending with Addon 2.

EAN-13 Addon 2

**Enable EAN-13
Addon 2**



***Disable**



Decide whether to read EAN-13 barcodes ending with Addon 5.

EAN-13 Addon 5

**Enable EAN-13
Addon 5**



***Disable**



4.16.1 EAN-13 ADDON MODES

Decide whether to enable EAN-13 414/419/434/439 Addon Mode. When enabled, barcodes starting with 414/419/434/439 won't be decoded if the scanned barcodes do not have the Addon 2 or Addon 5 suffix.

EAN-13 414/419/434/439 Addon Mode

Enable



***Disable**



101336

Decide whether to enable EAN-13 378/379 Addon Mode. When enabled, barcodes starting with 378/379 won't be decoded if the scanned barcodes do not have the Addon 2 or Addon 5 suffix.

EAN-13 378/379 Addon Mode

Enable



101339

***Disable**



101338

Decide whether to enable EAN-13 977 Addon Mode. When enabled, barcodes starting with 977 won't be decoded if the scanned barcodes do not have the Addon 2 or Addon 5 suffix.

EAN-13 977 Addon Mode

Enable



101341

***Disable**



101340

Decide whether to enable EAN-13 978 Addon Mode. When enabled, barcodes starting with 978 won't be decoded if the scanned barcodes do not have the Addon 2 or Addon 5 suffix.

EAN-13 978 Addon Mode

Enable



101343

***Disable**



101342

Decide whether to enable EAN-13 979 Addon Mode. When enabled, barcodes starting with 979 won't be decoded if the scanned barcodes do not have the Addon 2 or Addon 5 suffix.



EAN-13 979 Addon Mode

Enable



***Disable**



Decide whether to enable EAN-13 491 Addon Mode. When enabled, barcodes starting with 491 won't be decoded if the scanned barcodes do not have the Addon 2 or Addon 5 suffix.

EAN-13 491 Addon Mode

Enable



***Disable**



Decide whether to enable EAN-13 529 Addon Mode. When enabled, barcodes starting with 529 won't be decoded if the scanned barcodes do not have the Addon 2 or Addon 5 suffix.

EAN-13 529 Addon Mode

Enable



***Disable**



Decide whether to have the scanner buzzer sound two beeps (with tones descending from high to low) when decoding the scanned barcode that doesn't have the Addon 2 or Addon 5 suffix.



EAN-13 Addon Mode Buzzer

Enable



101335

*Disable



101334

4.16.2 CONVERT TO ISBN

Decide whether to convert the EAN-13 barcode, starting with 978 and 979, to ISBN.

Convert EAN-13 to ISBN



100463

*Do Not Convert



100462

4.16.3 CONVERT TO ISSN

Decide whether to convert the EAN-13 barcode, starting with 977 to ISSN.

Convert EAN-13 to ISSN



100465

*Do Not Convert



100464

4.16.4 TRANSMIT CHECK DIGIT

Decide whether to include the check digit in the data being transmitted.

*Transmit EAN-13 Check Digit



100473



Do Not Transmit



4.17 UCC COUPON EXTENDED CODE

Decide whether to decode the following barcodes as Coupon Code.

- ▶ UPC-A barcodes starting with digit "5"
- ▶ EAN-13 barcodes starting with digits "99"
- ▶ UPC-A/EAN-128 Coupon Codes

Enable



*Disable



Note: Depending on your requirements, UPC-A, EAN-13 and EAN-128 must be enabled first!

4.18 UPC-A

UPC-A

*Enable UPC-A
(No Addon)



Disable



UPC-A Addon 2

Enable UPC-A Addon
2



*Disable



UPC-A Addon 5

Enable UPC-A Addon
5



*Disable



4.18.1 CONVERT TO EAN-13

Decide whether to expand the read UPC-A barcode, as well as its addons, into EAN-13.

- ▶ After conversion, the data follows EAN-13 format and is affected by EAN-13 programming selections (e.g. Check Digit).

Convert UPC-A to
EAN-13



*Do Not Convert



4.18.2 TRANSMIT SYSTEM NUMBER

Decide whether to include the system number in the data being transmitted.

*Transmit UPC-A
System Number



Do Not Transmit



4.18.3 TRANSMIT CHECK DIGIT

Decide whether to include the check digit in the data being transmitted.

*Transmit UPC-A
Check Digit



Do Not Transmit



100468

4.19 UPC-E

UPC-E

*Enable UPC-E
(No Addon)



100321

Disable



100320

UPC-E Addon 2

Enable UPC-E Addon
2



100323

*Disable



100322

UPC-E Addon 5

Enable UPC-E Addon
5



100325

*Disable



100324

4.19.1 SELECT SYSTEM NUMBER

Decide whether to decode the ordinary UPC-E barcodes only or both UPC-E0 and UPC-E1 barcodes.

- ▶ System number 0 enabled for decoding UPC-E0 barcodes.
- ▶ System number 1 enabled for decoding UPC-E1 barcodes.



System Number 0 &
1



*System Number 0
Only



Warning: Because of the way system number 1 is encoded, if both system numbers are enabled, the user might suffer from short scanning UPC-A or EAN-13 barcodes into UPC-E1 barcodes.

4.19.2 CONVERT TO UPC-A

Decide whether to expand the read UPC-E barcode, as well as its addons, into UPC-A.

- ▶ After conversion, the data follows UPC-A format and is affected by UPC-A programming selections (e.g. System Number, Check Digit).

Convert UPC-E to
UPC-A



*Do Not Convert



4.19.3 TRANSMIT SYSTEM NUMBER

Decide whether to include the system number in the data being transmitted.

Transmit UPC-E
System Number



*Do Not Transmit



4.19.4 TRANSMIT CHECK DIGIT

Decide whether to include the check digit in the data being transmitted.

*Transmit UPC-E
Check Digit



Do Not Transmit



100466



Update

4.20 CODE 11

Decide whether to decode Code 11.

Enable



*Disable



4.20.1 VERIFY CHECK DIGIT

Decide whether to verify the check digit(s). If incorrect, the barcode will not be accepted.

Verify One
Check Digit



Verify Two
Check Digit



*Do Not Verify



4.20.2 TRANSMIT CHECK DIGIT

Decide whether to include the check digit(s) in the data being transmitted.

Transmit Code 11
Check Digit



*Do Not Transmit



Note: "Verify Check Digit" must be enabled first.



4.20.3 CODE LENGTH QUALIFICATION

To prevent the "short scan" error, define the "Length Qualification" settings to ensure that the correct barcode is read by qualifying the allowable code length.

- ▶ If "Max/Min Length" is selected, the maximum length and the minimum length must be specified. It only accepts those barcodes with lengths that fall between max/min lengths specified.
- ▶ If "Fixed Length" is selected, up to 2 fixed lengths can be specified.

Note: The specified length(s) must include the check digit(s) the barcode contains.

- 1) Read the barcode to enable either Max. /Min. Length qualification or Fixed Length(s) qualification.

***Enable Max./Min.
Length (1~55)...**



**Enable Fixed
Length(s)...**



- 2) Read the barcode for Max. Length or Fixed Length 1, and follow steps 3~4.
Repeat steps 2~4 for Min. Length or Fixed Length 2.

**Max. Length (*55)
or Fixed Length 1**



**Min. Length (*4)
or Fixed Length 2**



- 3) Read the "Decimal Value" barcode on Appendix IV for the desired length.
- 4) Read the "Validate" barcode on Appendix IV to complete this setting.



4.21 COMPOSITE CODE

4.21.1 COMPOSITE CC-A/B

Decide whether to enable Composite CC-A/B

Enable Composite
CC-A/B



*Disable



Decide whether to enable GS1 formatting for Composite CC-A/B. When enabled, the field separator and application ID mark will be automatically added to the output data

Enable GS1
Formatting



*Disable GS1
Formatting



4.21.2 COMPOSITE CC-C

Decide whether to enable Composite CC-C.

Enable Composite
CC-C



*Disable



Decide whether to enable GS1 formatting for Composite CC-C. When enabled, the field separator and application ID mark will be automatically added to the output data.

Enable GS1
Formatting



* Disable GS1
Formatting



4.21.3 COMPOSITE TLC-39

Decide whether to enable Composite TLC-39.

**Enable Composite
TLC-39**



***Disable**



4.21.4 UPC COMPOSITE MODE

UPC barcodes can be “linked” with a 2D barcode during transmission as if they were one barcode.

▶ **UPC Never Linked**

Transmit UPC barcodes regardless of whether a 2D barcode is detected.

▶ **UPC Always Linked**

Transmit UPC barcodes and the 2D portion. If the 2D portion is not detected, the UPC barcode will not be transmitted.

Note: CC-A/B or CC-C must be enabled!

▶ **Auto-discriminate UPC Composites**

Transmit UPC barcodes as well as the 2D portion if present.

UPC Never Linked



***UPC Always Linked**



Auto-discriminate



4.21.5 GS1-128 EMULATION MODE FOR UCC/EAN COMPOSITE CODES

Decide whether to transmit UCC/EAN Composite Code data as if it was encoded in GS1-128 barcodes.

Enable GS1-128
Emulation Mode



*Disable



4.21.6 FIELD SEPARATOR (GS CHARACTER)

Decide whether to apply a field separator (to convert the GS control character to human readable character). The field separator is automatically added to the data when GS1 formatting is enabled.

Specify Field
Separator...



- 1) Read the barcode above to specify field separator.
- 2) Read the "[Hexadecimal Value](#)" barcode on Appendix IV for the desired character string.
- 3) Read the "Validate" barcode on Appendix IV to complete this setting.

4.21.7 APPLICATION ID MARK

You may want to add an application ID mark (1 character long) to the left (AIMark1) or right (AIMark2) of an application ID (AI) for the purpose of labeling it when formatting the GS1 data. The application ID mark is automatically added to the data when GS1 formatting is enabled.

AIMark1



AIMark2



- 1) Read the barcode above to add a mark to the left (AIMark1)/right (AIMark2) of an application ID.
- 2) Read the "[Hexadecimal System](#)" barcode on Appendix IV for the desired character. Read '00' if you want to remove the AI mark.
- 3) Read the "Validate" barcode on Appendix IV to complete this setting.



4.22 US POSTAL CODE

4.22.1 US POSTNET

Decide whether to decode US Postnet.

***Enable US Postnet**



102017

Disable



102016

4.22.2 US PLANET

Decide whether to decode US Planet.

***Enable US Planet**



102019

Disable



102018

4.22.3 TRANSMIT CHECK DIGIT

Decide whether to include the check digit in the data being transmitted.

***Transmit US
Postal Check Digit**



102111

Do Not Transmit



102110



4.23 UK POSTAL CODE

4.23.1 UK POSTAL

Decide whether to decode UK Postal.

***Enable UK Postal**



102021

Disable



102020

4.23.2 TRANSMIT CHECK DIGIT

Decide whether to include the check digit in the data being transmitted.

***Transmit UK
Postal Check Digit**



102109

Do Not Transmit



102108

4.24 MORE POSTAL CODE

4.24.1 JAPAN POSTAL

Decide whether to decode Japan Postal.

***Enable Japan
Postal**



102023

Disable



102022



4.24.2 AUSTRALIAN POSTAL

Decide whether to decode Australian Postal.

***Enable
Australian Postal**



102025

Disable



102024

4.24.3 DUTCH POSTAL

Decide whether to decode Dutch Postal.

***Enable Dutch
Postal**



102027

Disable



102026

4.24.4 USPS 4CB/ONE CODE/INTELLIGENT MAIL

Decide whether to decode USPS 4CB/One Code/Intelligent Mail.

**Enable USPS 4CB/
One Code/
Intelligent Mail**



102029

***Disable**



102028

4.24.5 UPU FICS POSTAL

Decide whether to decode UPU FICS Postal.

**Enable UPU FICS
Postal**



102031

***Disable**



102030



4.25 2D SYMBOLOGIES

4.25.1 PDF417

Decide whether to decode PDF417.

***Enable PDF417**



Disable



4.25.2 MicroPDF417

Decide whether to decode MicroPDF417.

**Enable
MicroPDF417**



***Disable**



4.25.3 DATA MATRIX

Decide whether to decode Data Matrix.

***Enable Data
Matrix**



Disable



GS1 FORMATTING

Decide whether to enable GS1 formatting for GS1-Data Matrix barcodes. When enabled, the field separator and application ID mark will be automatically added to the output data.

Enable



*Disable



101497

FIELD SEPARATOR

Decide whether to apply a field separator (to convert the GS control character to human readable character). The field separator is automatically added to the data when GS1 formatting is enabled.

Specify Field Separator...



100616

- 1) Read the barcode above to specify field separator.
- 2) Read the "[Hexadecimal Value](#)" barcode on Appendix IV for the desired character string.
- 3) Read the "Validate" barcode on Appendix IV to complete this setting.

APPLICATION ID MARK

You may want to add an application ID mark (1 character long) to the left (AIMark1) or right (AIMark2) of an application ID (AI) for the purpose of labeling it when formatting the GS1 data.

AIMark1



100620

AIMark2



100621

- 1) Read the barcode above to add a mark to the left (AIMark1)/right (AIMark2) of an application ID.
- 2) Read the "[Hexadecimal Value](#)" barcode on Appendix IV for the desired character. Read '00' if you want to remove the AI mark.
- 3) Read the "Validate" barcode on Appendix IV to complete this setting.



ECI INFORMATION

Users can determine whether to show the embedded ECI information when scanning a barcode.

Enable



*Disable



4.25.4 MAXICODE

Decide whether to decode Maxicode.

*Enable Maxicode



Disable



4.25.5 QR CODE

Decide whether to decode QR Code.

*Enable QR Code



Disable



GS1 FORMATTING

Decide whether to enable GS1 formatting for GS1-Data QR Code barcodes. When enabled, the field separator and application ID mark will be automatically added to the output data.

Enable



*Disable



FIELD SEPARATOR (GS CHARACTER)

Decide whether to apply a field separator (to convert the GS control character to human readable character). The field separator is automatically added to the data when GS1 formatting is enabled.

Specify Field Separator...



- 1) Read the barcode above to specify field separator.
- 2) Read the "[Hexadecimal Value](#)" barcode on Appendix IV for the desired character string.
- 3) Read the "Validate" barcode on Appendix IV to complete this setting.

APPLICATION ID MARK

You may want to add an application ID mark (1 character long) to the left (AIMark1) or right (AIMark2) of an application ID (AI) for the purpose of labeling it when formatting the GS1 data.

AIMark1



AIMark2



- 1) Read the barcode above to add a mark to the left (AIMark1)/right (AIMark2) of an application ID.
- 2) Read the "[Hexadecimal Value](#)" barcode on Appendix IV for the desired character. Read '00' if you want to remove the AI mark.
- 3) Read the "Validate" barcode on Appendix IV to complete this setting.



4.25.6 MicroQR

Decide whether to decode Micro QR.

***Enable MicroQR**



102043

Disable



102042

4.25.7 AZTEC

Decide whether to decode Aztec.

***Enable Aztec**



102045

Disable



102044



4.26 MACRO PDF

Macro PDF is a special feature for concatenating multiple PDF barcodes into one file, known as Macro PDF417 or Macro MicroPDF417.

Note: When printing barcodes, keep each Macro PDF sequence separate, as each has a unique identifier. Do not mix barcodes from several Macro PDF sequences, even if they encode the same data. When you scan Macro PDF sequences, scan the entire Macro PDF sequence without interruption!

4.26.1 TRANSMIT/DECODE MODE

Decide how to handle Macro PDF decoding.

- ▶ Buffer All Symbols / Transmit Macro PDF When Complete

Transmit all decoded data from an entire Macro PDF sequence only when the entire sequence is scanned and decoded. If the decoded data exceeds the limit of 50 symbols, no transmission because the entire sequence was not scanned!

- ▶ Transmit Any Symbol in Set / No Particular Order

Transmit data from each Macro PDF symbol as decoded, regardless of the sequence.

- ▶ Passthrough All Symbols

Transmit and decode all Macro PDF symbols and perform no processing. In this mode, the host is responsible for detecting and parsing the Macro PDF sequences.

Buffer All Symbols /
Transmit When Complete



Transmit Any Symbol in Set /
No Particular Order



*Passthrough All Symbols



4.26.2 ESCAPE CHARACTERS

When enabled, it uses the backslash "\" as an Escape character for systems that can process transmissions containing special data sequences. It will format special data according to the Global Label Identifier (GLI) protocol, which only affects the data portion of a Macro PDF symbol transmission. The Control Header, if enabled, is always sent with GLI formatting.

GLI Protocol



102198

*None



102196

4.26.3 TRANSMIT CONTROL HEADER

The control header contains the segment index and file ID. For example, the field may be "\92800000\725\120\343". The five digits after the \928 are the segment index (or block index), and \725\120\343 is the file ID.

- ▶ Enable this when selecting "Transmit Any Symbol in Set/ No Particular Order".
- ▶ Disable this when selecting "Buffer All Symbols/Transmit Macro PDF When Complete".
- ▶ This option has no effect when selecting "Passthrough All Symbols".

Transmit Control Header



102195

*Do Not Transmit



102194



DEFINING OUTPUT FORMAT

Users can configure the data output format in which the collected data will be output to the host computer. Barcodes read by the scanner will be processed in the following sequence –

- 1) Perform character substitution on the data scanned.
- 2) Add [Code ID](#) and [Length Code](#) to the front of the data: [Code ID] [Length Code] [Data]
- 3) Process the whole data in step 2 with user formats. Data is now divided into fields by user specified rules. Refer to [Chapter 6 Applying Formats for Data Editing](#).
- 4) Add [Prefix Code](#) and [Suffix Code](#) before transmission: [Prefix Code] [Processed Data] [Suffix Code]

IN THIS CHAPTER

5.1 Letter Case	160
5.2 Character Substitution	160
5.3 Prefix/Suffix Code	174
5.4 Code ID	175
5.5 Length Code	182
5.6 Multi-Barcode Editor	190
5.7 Removal of Special Character	193
5.8 AIM Code ID	194



5.1 LETTER CASE

By default, the alphabets transmission is case-sensitive, meaning that the alphabets will be transmitted according to their original case. Ignoring the original letter case, select [Upper Case] to output data in upper case only; otherwise, select [Lower Case] to output data in lower case only.

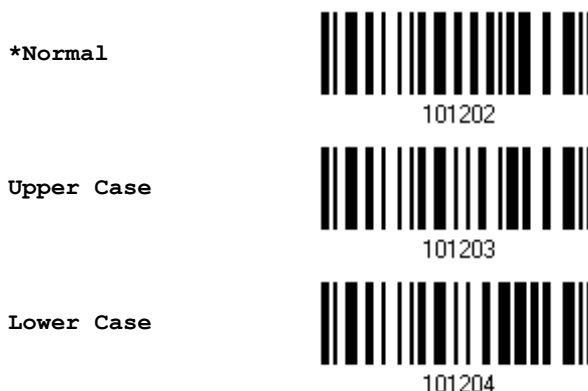

5.2 CHARACTER SUBSTITUTION

Character substitution is performed on every occurrence of the first character specified. If only one character is specified, every occurrence of that character in the barcode will be taken away.

- ▶ The first character will be replaced by the second character(s).
- ▶ Up to three sets of character substitution can be configured.
- ▶ If "BT HID" or "USB HID" is configured as interface, [Key Type](#) and [Key Status](#) will then become applicable. You may decide whether to apply Key Status when "Normal Key" is selected as Key Type.

Key Type		Key Status
Scan Code	Only 1 scan code value is allowed. Refer to Section 5.2.1 Single Character Substitution .	N/A
Normal Key	Up to 3 character strings are allowed.	<ul style="list-style-type: none"> ▶ Add Shift ▶ Add Left Ctrl ▶ Add Left Alt ▶ Add Right Ctrl ▶ Add Right Alt Refer to Appendix III 錯誤! 找不到參照來源。

Note: The character substitution is performed only on the barcode itself and before the processing of editing formats. It is not applicable to the Prefix/Suffix Code, Code ID, Length Code, or any Additional Field.



5.2.1 SINGLE CHARACTER SUBSTITUTION

Please follow steps below to replace a single character with one or more characters.

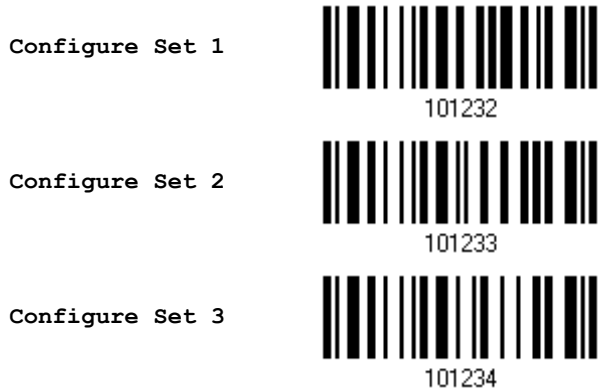

- 1) Read the barcode above to enable character substitution by set.

For example, have the scanner read the "Set 1" barcode to configure the first set of character substitution. The scanner will respond with one short beep, high tone, to indicate more setup barcodes are required.

- 2) Read the "[Hexadecimal Value](#)" barcode on Appendix IV for the desired character substitution. The first character specified is the target one to be replaced; then the character(s) specified after the first one will be the replacement character(s). For example:

Key Type = Normal

- ▶ Read "3", "0", "2", and "D" to replace the character "0" with a dash "-".
- ▶ Read "3", "0", "2", "D", "3", and "0" to replace the character "0" with a dash "-0".

Key Type = Scan Code

If you want to replace the character "0" with "a" (= "1C" on the scan code table):

1. Read "3" and "0".
2. Read the "Scan Code" barcode.
3. Read "1" and "C".

Key Type = Normal + Key Status = Shift

If you want to replace the character "0" with "!" (= "Shift" + "1" on keyboard):

1. Read "3" and "0".
2. Read the "Add Shift" barcode.
3. Read "3" and "1".

- 3) Read the "Validate" barcode on Appendix IV to complete this setting. (The defined set or sets will be applied to all symbologies by default.)



5.2.2 MULTIPLE CHARACTER SUBSTITUTION

Users can replace a string up to 16 characters with another one.

Configure Set 1

Set 1
Target String



Set 1
Replacement
String



Configure Set 2

Set 2
Target String



Set 2
Replacement
String



Configure Set 3

Set 3
Target String



Set 3
Replacement
String



Please follow steps below:

- 1) Respectively read the "Target String" and "Replacement String" barcodes above to enable string substitution by set.

For example, have the scanner read the "Target String" barcode of "Set 1" to specify the target characters to be replaced. Then the scanner will respond with one short beep indicating users to proceed with barcode reading for target characters.

Read the "[Hexadecimal Value](#)" barcode on Appendix IV for the desired characters.

- 2) Read the "Validate" barcode on Appendix IV to complete this setting. (The defined set or sets will be applied to all symbologies by default.)
- 3) After specifying the target characters, have the scanner read the "Replacement String" barcode of "Set 1" to specify the replacement characters. Read the "[Hexadecimal Value](#)" barcode on Appendix IV for the desired characters. For example,
- 4) Read the "Validate" barcode on Appendix IV to complete this setting. (The defined set or sets will be applied to all symbologies by default.)

For example,

Key Type = Normal

Replace the character "0-0" with "***":

1. Read the Target String barcode.
2. Read "3", "0", "2", "D", "3", and "0" barcodes to specify the target string "0-0" (zero, dash, zero).
3. Read the Validate barcode.



4. Read the Replacement String barcode.
5. Read "2", "A", "2", "A", "2", and "A" barcodes to specify the replacement string "****" (stars).
6. Read the Validate barcode.

Key Type = Scan Code

Replace the character "0-0" with "****" ("*" = "3E" on the scan code table):

1. Read the Target String barcode.
2. Read "3", "0", "2", "D", "3", and "0" barcodes to specify the target string "0-0" (zero, dash, zero).
3. Read the Validate barcode.
4. Read the Replacement String barcode.
5. Read the "Scan Code" barcode.
6. Read "3", "E", "3", "E", "3", and "E" barcodes to specify the replacement string "****" (stars).
7. Read the Validate barcode.

Key Type = Normal + Key Status = Shift

Replace the character "0-0" with "!!!" ("!" = "Shift" + "1" on keyboard):

1. Read the Target String barcode.
2. Read "3", "0", "2", "D", "3", and "0" barcodes to specify the target string "0-0" (zero, dash, zero).
3. Read the Validate barcode.
4. Read the Replacement String barcode.
5. Read the "Add Shift" barcode.
6. Read "3", "1", "3", "1", "3", and "1".
7. Read the Validate barcode.



5.2.3 SYMBOLOGIES FOR CHARACTER SUBSTITUTION (ALL 3 SETS)

By default, character substitution will be performed on all symbologies. If the character substitution is not desired with one or more symbologies, read the "Do Not Apply" barcode for each undesired symbologies and all the three sets will be ignored for them.

Character Substitution for Codabar

*Apply



101253

Do Not Apply



101252

Character Substitution for Code 39

*Apply



101241

Do Not Apply



101240

Character Substitution for Trioptic Code 39

*Apply



102607

Do Not Apply



102606

Character Substitution for Code 93

*Apply



101255

Do Not Apply



101254



Character Substitution for Code 128

***Apply**



101257

Do Not Apply



101256

Character Substitution for GS1-128

***Apply**



101259

Do Not Apply



101258

Character Substitution for ISBT 128

***Apply**



101293

Do Not Apply



101292

Character Substitution for EAN-8 (No Addon)

***Apply**



101267

Do Not Apply



101266

Character Substitution for EAN-8 Addon 2

***Apply**



101269

Do Not Apply



101268



Character Substitution for EAN-8 Addon 5

***Apply**



101271

Do Not Apply



101270

Character Substitution for EAN-13 (No Addon)

***Apply**



101273

Do Not Apply



101272

Character Substitution for EAN-13 Addon 2

***Apply**



101275

Do Not Apply



101274

Character Substitution for EAN-13 Addon 5

***Apply**



101277

Do Not Apply



101276

Character Substitution for Italian Pharmacode

***Apply**



101243

Do Not Apply



101242



Character Substitution for Industrial 25

***Apply**



101247

Do Not Apply



101246

Character Substitution for Interleaved 25

***Apply**



101249

Do Not Apply



101248

Character Substitution for Matrix 25

***Apply**



101251

Do Not Apply



101250

Character Substitution for Chinese 25

***Apply**



102617

Do Not Apply



102616

Character Substitution for MSI

***Apply**



101285

Do Not Apply



101284



Character Substitution for GS1 DataBar

*Apply



101291

Do Not Apply



101290

Character Substitution for UPC-A (No Addon)

*Apply



101279

Do Not Apply



101278

Character Substitution for UPC-A Addon 2

*Apply



101281

Do Not Apply



101280

Character Substitution for UPC-A Addon 5

*Apply



101283

Do Not Apply



101282

Character Substitution for UPC-E (No Addon)

*Apply



101261

Do Not Apply



101260



Character Substitution for UPC-E Addon 2

***Apply**



101263

Do Not Apply



101262

Character Substitution for UPC-E Addon 5

***Apply**



101265

Do Not Apply



101264

Character Substitution for UCC Coupon Extended Code

***Apply**



102605

Do Not Apply



102604

Character Substitution for Code 11

***Apply**



102609

Do Not Apply



102608

Character Substitution for Composite CC-A/B

***Apply**



102611

Do Not Apply



102610



Character Substitution for Composite CC-C

***Apply**



102613

Do Not Apply



102612

Character Substitution for Composite TLC-39

***Apply**



102615

Do Not Apply



102614

Character Substitution for US Postnet

***Apply**



102619

Do Not Apply



102618

Character Substitution for US Planet

***Apply**



102621

Do Not Apply



102620

Character Substitution for UK Postal

***Apply**



102623

Do Not Apply



102622



Character Substitution for Japan Postal

***Apply**



102625

Do Not Apply



102624

Character Substitution for Australian Postal

***Apply**



102627

Do Not Apply



102626

Character Substitution for Dutch Postal

***Apply**



102629

Do Not Apply



102628

Character Substitution for USPS 4CB/One Code/Intelligent Mail

***Apply**



102631

Do Not Apply



102630

Character Substitution for UPU FICS Postal

***Apply**



102633

Do Not Apply



102632



Character Substitution for PDF417

***Apply**



102635

Do Not Apply



102634

Character Substitution for MicroPDF417

***Apply**



102637

Do Not Apply



102636

Character Substitution for Data Matrix

***Apply**



102639

Do Not Apply



102638

Character Substitution for Maxicode

***Apply**



102641

Do Not Apply



102640

Character Substitution for QR Code

***Apply**



102643

Do Not Apply



102642



Character Substitution for MicroQR

***Apply**



102645

Do Not Apply



102644

Character Substitution for Aztec

***Apply**



102647

Do Not Apply



102646



5.3 PREFIX/SUFFIX CODE

By default, there is no prefix code, and [ENTER] or [CR] (Carriage Return) is configured to be suffix code. Up to 8 characters can be configured, for example, "Barcode_", and you will have the string appear in front of the barcode read, like this - "Barcode_1234567890".

- ▶ If "BT HID" or "USB HID" is configured as interface, [Key Type](#) and [Key Status](#) will then become applicable. You may decide whether to apply Key Status when "Normal Key" is selected as Key Type.

Key Type		Key Status
Scan Code	Up to 4 scan code values are allowed.	N/A
Normal Key	Up to 8 character strings are allowed.	<ul style="list-style-type: none"> ▶ Add Shift ▶ Add Left Ctrl ▶ Add Left Alt ▶ Add Right Ctrl ▶ Add Right Alt Refer to Appendix III <small>錯誤! 找不到參照來源。</small>

Configure Prefix



101230

Configure Suffix



101231

- 1) Read the barcode above to apply prefix code or suffix code separately, and follow steps 2~3. (Max. 8 characters each)
- 2) Read the "[Hexadecimal Value](#)" barcode on Appendix IV for the desired character string. For example, read "2" and "B" for the scanner to prefix or suffix the character [+].
- 3) Read the "Validate" barcode on Appendix IV to complete this setting.



5.4 CODE ID

Up to two characters for Code ID can be configured for each symbology. To make the Code ID configuration easier, the scanner provides five pre-defined Code ID sets from which you can select one and make necessary changes on it.

- ▶ If "BT HID" or "USB HID" is configured as interface, [Key Type](#) and [Key Status](#) will then become applicable. You may decide whether to apply Key Status when "Normal Key" is selected as Key Type.

Key Type		Key Status
Scan Code	Only 1 scan code value is allowed.	N/A
Normal Key	Up to 2 character strings are allowed.	<ul style="list-style-type: none"> ▶ Add Shift ▶ Add Left Ctrl ▶ Add Left Alt ▶ Add Right Ctrl ▶ Add Right Alt Refer to Appendix III Keyboard Wedge Table ..

Note: "]C1" is the Code ID of GS1-128 (EAN-128) barcodes; "]e0" is the default Code ID of GS1 DataBar (RSS) barcodes.

5.4.1 SELECT PRE-DEFINED CODE ID

Apply Code ID Set 1



Apply Code ID Set 2



Apply Code ID Set 3



Apply Code ID Set 4



Apply Code ID Set 5



Code ID options	Set 1	Set 2	Set 3	Set 4	Set 5
Code 39	A	C	Y	M	A
Trioptic Code 39	A	C	Y	M	X
Italian Pharmacode	A	C	Y	M	A
Industrial 25	C	H	H	H	S
Interleaved 25	D	I	Z	I	S
Matrix 25	E	G	G	G	S
Chinese 25	Q	M	P	S	X
Codabar	F	N	X	N	F
Code 93	I	L	L	L	G
Code 128	H	K	K	K	C
ISBT 128	H	K	K	K	C
UPC-E	S	E	C	E	E
EAN-8	P	B	B	FF	E
EAN-13	M	A	A	F	E
UPC-A	J	A	A	A	E
MSI	V	V	D	P	M
UCC Coupon Code	G	F	I	C	C
Code 11	K	J	J	D	H
Composite CC-A/B	L	X	M	J	La
Composite CC-C	N	Y	N	O	Lc
Composite TLC-39	O	Z	O	R	L2
US Postnet	h	a	s	i	X
US Planet	i	b	t	j	X
UK Postal	j	c	u	k	X
Japan Postal	k	d	v	l	X
Australian Postal	l	e	w	m	X
Dutch Postal	m	f	x	n	X
USPS 4 CB / One Code / Intelligent Mail	n	g	y	o	X
UPU FICS Postal	o	h	z	p	X
PDF417	a	O	W	T	L
MicroPDF417	b	P	V	U	L
Data Matrix	c	Q	U	V	d
Maxicode	d	R	T	W	U



QR Code	e	S	S	X	Q
MicroQR	f	T	R	Y	Q
Aztec	g	U	Q	Z	z
IATA	z	z	r	h	S
Macro PDF417	p	i	a	q	L
Macro MicroPDF417	q	j	b	r	L



5.4.2 CHANGE CODE ID

- 1) Read the barcode below to change code ID of a specific symbology.
- 2) Read the "[Hexadecimal Value](#)" barcode on Appendix IV for the desired character string. For example, read "4" and "4" for applying the character [D] for Code ID.
- 3) Read the "Validate" barcode on Appendix IV to complete this setting.

Configure Code ID
for Codabar



101456

Configure Code ID
for Code 39



101450

Configure Code ID
for Trioptic Code
39



102566

Configure Code ID
for Code 93



101457

Configure Code ID
for Code 128



101458

Configure Code ID
for ISBT 128



101466

Configure Code ID
for EAN-8



101460

Configure Code ID
for EAN-13



101461

Configure Code ID
for Italian
Pharmacode















101451

Configure Code ID
for Industrial 25



101453







Configure Code ID for Interleaved25	 101454
Configure Code ID for Matrix 25	 101455
Configure Code ID for Chinese 25	 102571
Configure Code ID for MSI	 101463
Configure Code ID for UPC-A	 101462
Configure Code ID for UPC-E	 101459
Configure Code ID for UCC Coupon Code	 102565
Configure Code ID for Code 11	 102567
Configure Code ID for Composite CC-A/B	 102568
Configure Code ID for Composite CC-C	 102569
Configure Code ID for Composite TLC-39	 102570
Configure Code ID for US Postnet	 102572



Configure Code ID for US Planet	 102573
Configure Code ID for UK Postal	 102574
Configure Code ID for Japan Postal	 102575
Configure Code ID for Australian Postal	 102576
Configure Code ID for Dutch Postal	 102577
Configure Code ID for USPS 4CB / One Code / Intelligent Mail	 102578
Configure Code ID for UPU FICS Postal	 102579
Configure Code ID for PDF417	 102580
Configure Code ID for MicroPDF417	 102581
Configure Code ID for Data Matrix	 102582
Configure Code ID for Maxicode	 102583
Configure Code ID for QR Code	 102584



Configure Code ID for MicroQR	 102585
Configure Code ID for Aztec	 102586
Configure Code ID for IATA	 102587
Configure Code ID for Macro PDF417	 102588
Configure Code ID for Macro MicroPDF417	 102589

5.4.3 CLEAR CODE ID SETTINGS

Clear All Code ID Settings	 109960
-------------------------------	---



5.5 LENGTH CODE

A 4-digit code representing the length of barcode data (character count) can be inserted in front of data being transmitted. Such "Length" code can be individually enabled or disabled for each symbology.

Length Code for Codabar

Apply



*Do Not Apply



Length Code for Code 39

Apply



*Do Not Apply



Length Code for Trioptic Code 39

Apply



*Do Not Apply



Length Code for Code 93

Apply



*Do Not Apply



Length Code for Code 128

Apply



101417

*Do Not Apply



101416

Length Code for GS1-128 & GS1 DataBar

Apply



101419

*Do Not Apply



101418

Length Code for ISBT 128

Apply



101435

*Do Not Apply



101434

Length Code for EAN-8

Apply



101423

*Do Not Apply



101422

Length Code for EAN-13

Apply



101425



*Do Not Apply



101424

Length Code for Italian Pharmacode

Apply



101403

*Do Not Apply



101402

Length Code for Industrial 25

Apply



101407

*Do Not Apply



101406

Length Code for Interleaved 25

Apply



101409

*Do Not Apply



101408

Length Code for Matrix 25

Apply



101411

*Do Not Apply



101410

Length Code for Chinese 25

Apply



102515



*Do Not Apply



102514

Length Code for MSI

Apply



101429

*Do Not Apply



101428

Length Code for UPC-A

Apply



101427

*Do Not Apply



101426

Length Code for UPC-E

Apply



101421

*Do Not Apply



101420

Length Code for UCC Coupon Extended Code

Apply



102503

*Do Not Apply



102502

Length Code for Code 11

Apply



102507



*Do Not Apply



102506

Length Code for Composite CC-A/B

Apply



102509

*Do Not Apply



102508

Length Code for Composite CC-C

Apply



102511

*Do Not Apply



102510

Length Code for Composite TLC-39

Apply



102513

*Do Not Apply



102512

Length Code for US Postnet

Apply



102517

*Do Not Apply



102516

Length Code for US Planet

Apply



102519



*Do Not Apply



102518

Length Code for UK Postal

Apply



102521

*Do Not Apply



102520

Length Code for Japan Postal

Apply



102523

*Do Not Apply



102522

Length Code for Australian Postal

Apply



102525

*Do Not Apply



102524

Length Code for Dutch Postal

Apply



102527

*Do Not Apply



102526

Length Code for USPS 4CB/One Code/Intelligent Mail

Apply



102529



*Do Not Apply



102528

Length Code for UPU FICS Postal

Apply



102531

*Do Not Apply



102530

Length Code for PDF417

Apply



102533

*Do Not Apply



102532

Length Code for MicroPDF417

Apply



102535

*Do Not Apply



102534

Length Code for Data Matrix

Apply



102537

*Do Not Apply



102536

Length Code for Maxicode

Apply



102539



*Do Not Apply



102538

Length Code for QR Code

Apply



102541

*Do Not Apply



102540

Length Code for MicroQR

Apply



102543

*Do Not Apply



102542

Length Code for Aztec

Apply



102545

*Do Not Apply



102544



5.6 MULTI-BARCODE EDITOR

The Multi-Barcode Editor allows users to decide the output sequence of a concatenation of barcodes. Up to five barcodes can be specified. Enabling this mode will force the scanner to apply Laser mode as the scan mode. For the scanner to concatenate barcodes, the maximum output data length of all the barcodes is 10 KB after configuration. When the data length exceeds 10 KB, the concatenation will not take effect.

Note: The Multi-Barcode Editor has nothing to do with [Section 1.6.6 Multi-Barcode Mode](#).

The barcodes that are found meeting the specified criteria below will be arranged in the desired sequence.

- ▶ Code Type
- ▶ 4-digit barcode length, excluding prefix, suffix, length code, etc.
- ▶ Matching the first character of barcode data

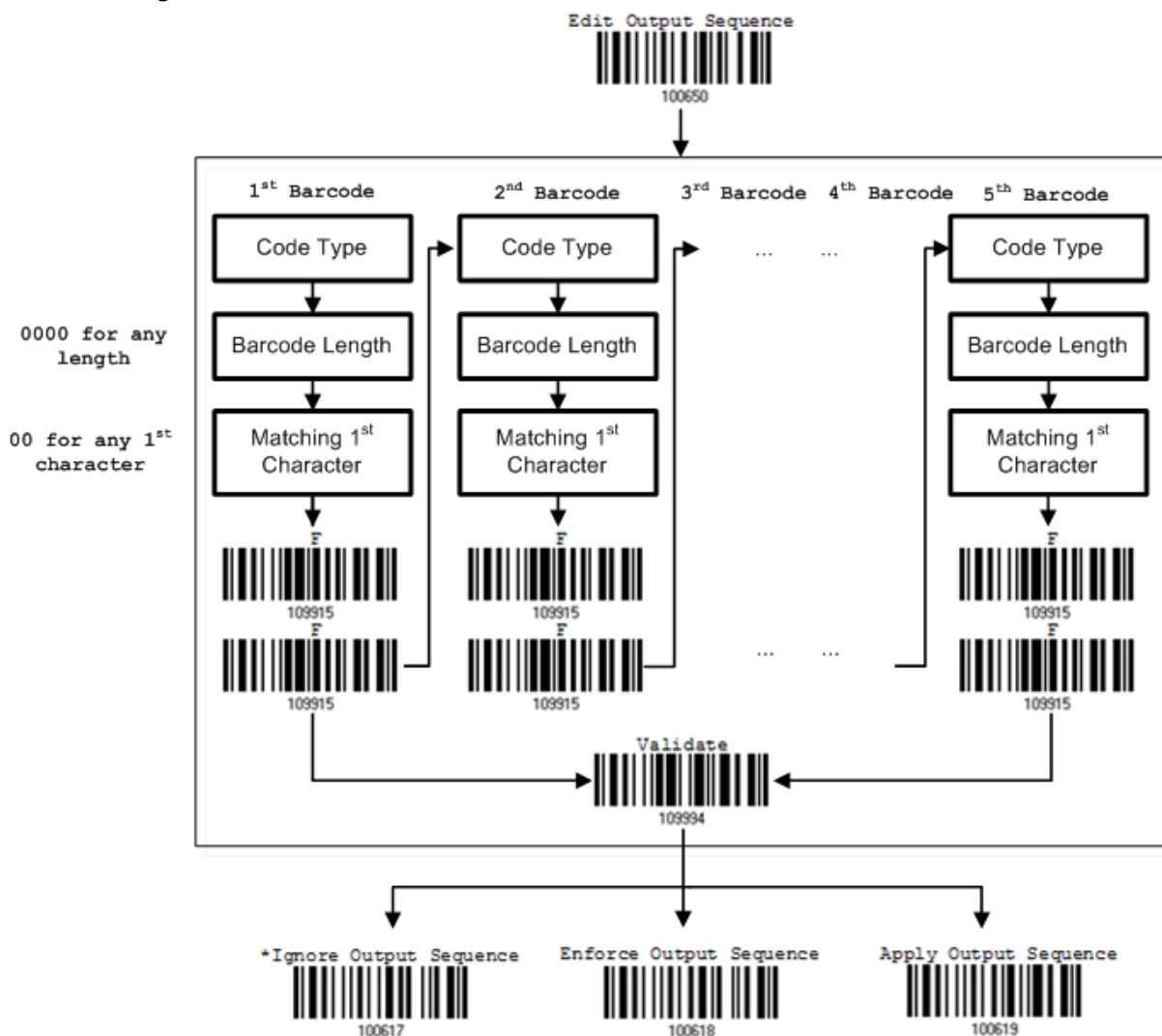

5.6.1 EDIT A CONCATENATION OF BARCODES

Edit Output
Sequence



- 1) Read the barcode above to start editing a concatenation of barcodes.
- 2) Code Type setting – read the “[Hexadecimal Value](#)” barcode on Appendix IV for Code Type of the (first) barcode. For example, read “4” and “1” for Code 39.

Code Type	Symbology	Code Type	Symbology
40 (@)	ISBT 128		
41 (A)	Code 39		
42 (B)	Italian Pharmacode		
43 (C)	N/A		
44 (D)	Industrial 25	64 (d)	TLC-39 (TCIF Linked Code 39)
45 (E)	Interleaved 25	65 (e)	Trioptic Code 39
46 (F)	Matrix 25		
47 (G)	Codabar (NW7)	67 (g)	Code 11
48 (H)	Code 93		
49 (I)	Code 128		
4A (J)	UPC-E0 / UPC-E1	6A (j)	Composite CC-C
4B (K)	UPC-E with Addon 2	6B (k)	PDF417
4C (L)	UPC-E with Addon 5	6C (l)	MicroPDF417
4D (M)	EAN-8	6D (m)	Data Matrix
4E (N)	EAN-8 with Addon 2	6E (n)	Maxicode
4F (O)	EAN-8 with Addon 5	6F (o)	QR Code
50 (P)	EAN-13	70 (p)	US Postnet
51 (Q)	EAN-13 with Addon 2	71 (q)	US Planet
52 (R)	EAN-13 with Addon 5	72 (r)	UK Postal
53 (S)	MSI	73 (s)	Japan Postal
54 (T)	N/A	74 (t)	Australian Postal



55 (U)	GS1-128 (EAN-128)	75 (u)	Dutch Postal
56 (V)	UPC-A	76 (v)	Composite CC-A/B
57 (W)	UPC-A with Addon 2	77 (w)	Macro PDF417
58 (X)	UPC-A with Addon 5	78 (x)	Macro MicroPDF417
		79 (y)	Chinese 25
5A (Z)	N/A	7A (z)	Aztec
5B ([)	GS1 DataBar (RSS)	7B ({ }	Micro QR
		7C ()	USPS 4CB / One Code / Intelligent Mail
		7D (})	UPU FICS Postal
		7E (~)	UCC Coupon Extended Code

- Barcode Length setting – read the “Decimal Value” barcode on Appendix IV for the 4-digit length of the (first) barcode. For example, read “0065” for barcode length of 65 characters or read “0000” for any length.

Note: If not reading 0000 for any length, the 4-digit length must exclude prefix, suffix (0x0d by default), length code, etc.

- Matching Character setting – read the “[Hexadecimal Value](#)” barcode on Appendix IV for the 1st character that must be found matching in the (first) barcode. For example, read “4” and “1” for matching character “A” as the first character in the barcode or read “00” for any character.
- Read twice the “F” barcode on Appendix IV (“FF”) to complete the setting of each barcode.
- Read the “Validate” barcode on Appendix IV to end the editing of the barcode set.

5.6.2 ACTIVATE THE CONCATENATION OF BARCODES

By default, the output sequence editing of the concatenation of barcodes is not applied. When “Enforce Output Sequence” is enabled, all barcodes read by the scanner must meet with the criteria for the concatenation. If data is found excluded from all output sequence sets (= not meeting with the criteria), the scanner will not accept the reading, and therefore, data will not be transmitted.

When “Apply Output Sequence” is enabled, only barcodes found meeting with the criteria are counted for the concatenation. Those found not meeting with the criteria are processed normally and individually.

Note: When it requires reading more barcodes to complete the “output sequence” requirements, the scanner will respond with one short beep (low tone). After reading an acceptable barcode, its LED indicator will become solid green and go off quickly (= Good Read). Upon completion of reading acceptable barcodes, the scanner will respond with one short beep (high tone) and its LED indicator will become solid green and go off quickly (= Good Read).



*Ignore Output Sequence



100617

Enforce Output Sequence



100618

Apply Output Sequence



100619

Warning:When you disable the Multi-Barcode Editor later, the scan mode remains unchanged. If Laser mode is not desired, proceed to select a scan mode best suits your application.

5.7 REMOVAL OF SPECIAL CHARACTER

A single character can be specified only. Every matching character from the starting position of barcode data will be removed until a different character is met. For example, if you specify the character "0" (hex value is "30") to be removed from barcode data, one or more zeros will be stripped off the barcode data "012345" and "00012345". However, for barcode data "010333", only the first zero will be stripped off.

Remove Special Character



101470

- 1) Read the barcode above to remove the specified character.
- 2) Read the "[Hexadecimal Value](#)" barcode on Appendix IV for the desired character string. For example, read "3" and "0" for the scanner to remove the character "0".
- 3) Read the "Validate" barcode on Appendix IV to complete this setting.



5.8 AIM CODE ID

You can add an AIM (Automatic Identification and Mobility) code ID in front of the barcode that shares the common purpose of identifying, tracking, recording, storing, and communicating essential business, personal, or product data. Enabling this function can have the scanner be capable of fast and accurate data collection and search.

***Disable**



102269

Enable



102270



APPLYING FORMATS FOR DATA EDITING

The scanner allows advanced data editing by applying user-configured editing formats. The whole processed data can be divided into fields by user-specified rules. These fields together with the user-configurable additional fields comprise the data actually sent to the host computer.

With the editing format applied, the maximum output data length of a barcode is 7 KB after configuration. If the data length exceeds 7 KB, editing format will not take effect.

[Prefix Code]	[Code ID]	[Length Code]	[Data]	[Suffix Code]	Additional Field(s)
None by default	None by default	None by default	Barcode itself	0x0d by default	User-defined field(s)

IN THIS CHAPTER

6.1 Activating Editing Formats.....	196
6.2 How to Configure Editing Formats	198
6.3 Configuring Format — Define Data Criteria	200
6.4 Configuring Format — Define Data Field.....	211
6.5 Configuring Format — Define Transmission Sequence....	219
6.6 Programming Examples	221



6.1 ACTIVATING EDITING FORMATS

6.1.1 ACTIVATE EDITING FORMATS

If you have already configured any editing format before, you may directly apply the editing format. If not, you must start with configuring an editing format first, and then, activate the editing format when it is desired in use.

Editing Format 1

Enable



*Disable



Editing Format 2

Enable



*Disable



Editing Format 3

Enable



*Disable



Editing Format 4

Enable



*Disable



Editing Format 5

Enable



101309

*Disable



101308

6.1.2 EXCLUSIVE DATA EDITING

By default, only barcodes found meeting with the criteria are processed by the editing formats. Those found not meeting with the criteria are processed normally. When "Exclusive Data Editing" is enabled, all barcodes read by the scanner must be processed by the editing formats. If data is found excluded from all enabled editing formats (= not meeting with the specified criteria), the scanner will not accept the reading, and therefore, data will not be transmitted.

Yes



101201

*No



101200



6.2 HOW TO CONFIGURE EDITING FORMATS

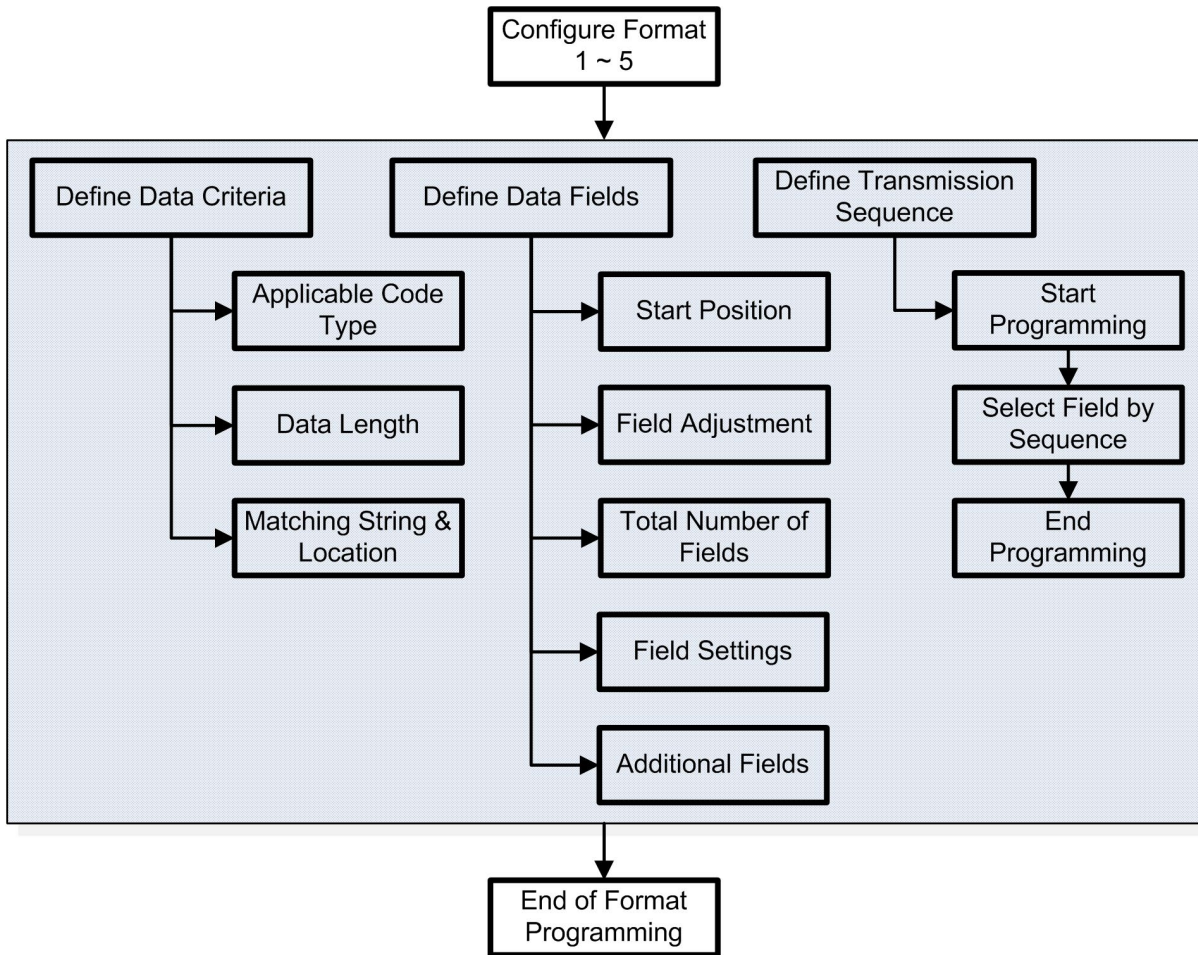

6.2.1 SELECT FORMAT TO CONFIGURE

Start Programming Format

Select one editing format (Format 1~5) and the parameters pertaining to the editing format can then be configured – applicable code type, data length, matching string & location, start position, field adjustment, total number of fields, field settings (field-dividing rule), additional fields, and field transmission sequence.

- ▶ Up to five different formats can be specified.

Configure Format 1





Note: Before you complete the programming of an editing format, if you have the scanner read any barcode for parameters other than those pertaining to the editing format, it will automatically abort the programming process.

End Programming Format

After having configured all the desired parameters, you must have the scanner read the “End Programming Format” barcode, which can be located at the bottom of every even page in this chapter.



6.2.2 RESTORE DEFAULT FORMAT

You may select an existing editing format and have the defaults restored. The default settings of an editing format are listed below.

Editing format	Defaults
Applicable Code Type	All
Data Length	0 (No qualification)
Matching String	Disable
Matching String Location	None
Start Position	From head
Field Adjustment	No adjustment
Total Number of Fields	1
Field Setting – field-dividing rule	Not configured



Additional Fields	None
Field Transmission Sequence	F1

Restore Default
Format



6.3 CONFIGURING FORMAT — DEFINE DATA CRITERIA

Three applicable conditions can be configured to check whether the data read by the scanner can be processed by the particular editing format.

Note: Data editing cannot be performed unless the three conditions are all met.

6.3.1 APPLICABLE CODE TYPE

By default, barcodes of all the supported symbologies will be processed by any editing format, if having been configured and enabled. For quick configuration, you may first clear all, and then select the desired symbologies.

Note: You must have at least one symbology selected.

*Apply to All



Clear All



Editing Format for Codabar

*Apply



Do Not Apply



Editing Format for Code 39

*Apply



Do Not Apply



101500

Editing Format for Trioptic Code 39

*Apply



101625

Do Not Apply



101624

Editing Format for Code 93

*Apply



101515

Do Not Apply



101514

Editing Format for Code 128

*Apply



101517

Do Not Apply



101516

Editing Format for GS1-128 & GS1 DataBar

*Apply



101519

Do Not Apply



101518

Editing Format for ISBT 128

*Apply



101553



Do Not Apply



101552

Editing Format for EAN-8

*Apply



101527

Do Not Apply



101526

Editing Format for EAN-8 Addon 2

*Apply



101529

Do Not Apply



101528

Editing Format for EAN-8 Addon 5

*Apply



101531

Do Not Apply



101530

Editing Format for EAN-13

*Apply



101533

Do Not Apply



101532

Editing Format for EAN-13 Addon 2

*Apply



101535



Do Not Apply



101534

Editing Format for EAN-13 Addon 5

*Apply



101537

Do Not Apply



101536

Editing Format for Italian Pharmacode

*Apply



101503

Do Not Apply



101502

Editing Format for Industrial 25

*Apply



101507

Do Not Apply



101506

Editing Format for Interleaved 25

*Apply



101509

Do Not Apply



101508

Editing Format for Matrix 25

*Apply



101511



Do Not Apply



101510

Editing Format for Chinese 25

*Apply



101635

Do Not Apply



101634

Editing Format for MSI

*Apply



101545

Do Not Apply



101544

Editing Format for UPC-A

*Apply



101539

Do Not Apply



101538

Editing Format for UPC-A Addon 2

*Apply



101541

Do Not Apply



101540

Editing Format for UPC-A Addon 5

*Apply



101543



Do Not Apply



101542

Editing Format for UPC-E

*Apply



101521

Do Not Apply



101520

Editing Format for UPC-E Addon 2

*Apply



101523

Do Not Apply



101522

Editing Format for UPC-E Addon 5

*Apply



101525

Do Not Apply



101524

Editing Format for UCC Coupon Extended Code

*Apply



101623

Do Not Apply



101622

Editing Format for Code 11

*Apply



101627



Do Not Apply



101626

Editing Format for Composite CC-A/B

*Apply



101629

Do Not Apply



101628

Editing Format for Composite CC-C

*Apply



101631

Do Not Apply



101630

Editing Format for Composite TLC-39

*Apply



101633

Do Not Apply



101632

Editing Format for US Postnet

*Apply



101637

Do Not Apply



101636

Editing Format for US Planet

*Apply



101639



Do Not Apply



101638

Editing Format for UK Postal

*Apply



101641

Do Not Apply



101640

Editing Format for Japan Postal

*Apply



101643

Do Not Apply



101642

Editing Format for Australian Postal

*Apply



101645

Do Not Apply



101644

Editing Format for Dutch Postal

*Apply



101647

Do Not Apply



101646

Editing Format for USPS 4CB/One Code/Intelligent Mail

*Apply



101649



Do Not Apply



101648

Editing Format for UPU FICS Postal

*Apply



101651

Do Not Apply



101650

Editing Format for PDF417

*Apply



101653

Do Not Apply



101652

Editing Format for MicroPDF417

*Apply



101655

Do Not Apply



101654

Editing Format for Data Matrix

*Apply



101657

Do Not Apply



101656

Editing Format for Maxicode

*Apply



101659



Do Not Apply



101658

Editing Format for QR Code

*Apply



101661

Do Not Apply



101660

Editing Format for MicroQR

*Apply



101663

Do Not Apply



101662

Editing Format for Aztec

*Apply



101665

Do Not Apply



101664



6.3.2 DATA LENGTH

The length must include prefix, suffix (0x0d by default), length code, etc. By default, barcodes of any length (character count) are eligible for data editing.

- ▶ Specify a value.
 - ▶ When zero is given to both, the scanner will not perform the length qualification.
- 1) Read the barcode below to specify Max. Length or Min. Length separately, and follow steps 2~3.



- 2) Read the "Decimal Value" barcode on Appendix IV for the desired length.
- 3) Read the "Validate" barcode on Appendix IV to complete this setting.

6.3.3 MATCHING STRING & LOCATION

By default, no matching string is specified, and therefore, it is disabled. You may enable this feature by specifying a matching string; up to four characters are allowed.

- ▶ When the Matching String Location is zero, the scanner will only check for the existence of the matching string in the barcode data.
 - ▶ Specify a value to indicate where the matching string starts in the barcode data.
- 1) Read the barcode to specify a matching string.



- 2) Read the "[Hexadecimal Value](#)" barcode on Appendix IV for the desired character string.
- 3) Read the "Validate" barcode on Appendix IV to complete this setting.
- 4) Read the barcode to specify the location of the matching string.



- 5) Read the "Decimal Value" barcode on Appendix IV for the desired location.
- 6) Read the "Validate" barcode on Appendix IV to complete this setting.



6.4 CONFIGURING FORMAT — DEFINE DATA FIELD

6.4.1 START POSITION

Data can be divided into fields in one of the following direction –

- ▶ from head (F1) to tail (F5)
- ▶ from tail (F1) to head (F5)

*From Head



101600

From Tail



101601

6.4.2 FIELD ADJUSTMENT

You may apply equal length to all fields, if necessary. If data is found longer than specified, it will be truncated automatically. When data is found shorter, it will add "Space" (0x20) to field.

*No adjustment



101602

Set length to
adjust fields...
(*0)



101603

- 1) Read the barcode above to adjust field by length.
- 2) Read the "Decimal Value" barcode on Appendix IV for the desired field length.
- 3) Read the "Validate" barcode on Appendix IV to complete this setting.



6.4.3 TOTAL NUMBER OF FIELDS

Data can be divided into at most 6 fields; each of them is numbered from F1 to F6 accordingly. However, only F1~F5 can be configured.

- ▶ The total number of fields must be specified correctly. If three fields are configured for the editing format, the data characters after F3 will be assigned to F4 automatically. This feature is quite useful especially when data of variable lengths is processed by editing formats.

***One Field**



101590

Two Fields



101591

Three Fields



101592

Four Fields



101593

Five Fields



101594

Six Fields



101595



6.4.4 FIELD SETTINGS

Data eligible for editing formats is divided into fields by user-specified rules – either using the field terminating string or specified field length.

By Terminating String

Specify the field terminating string. Up to two characters are allowed. The scanner will search for the occurrence of this particular string in the data.

- ▶ By default, this string will be included in the field. You may discard it.

By Length

Alternatively, you may simply specify the field length. The scanner will assign the next specified number of characters into the field.

Field 1 Setting

1. Read the barcode below to divide field 1 by a specified terminating string.

Select
Field Separator
to Divide Field 1...



2. Read the "[Hexadecimal Value](#)" barcode on Appendix IV for the desired character string.
3. Read the "Validate" barcode on Appendix IV to complete this setting.
4. Read the "Discard Separator" barcode if the field separator is not desired in the field.

*Include
Separator



Discard Separator



If not dividing the field by a specific separator, you may divide it by a specified length.

1. Read the barcode below to divide field 1 by length.

Divide Field 1
by Length



2. Read the "Decimal Value" barcode on Appendix IV for the desired field length.
3. Read the "Validate" barcode on Appendix IV to complete this setting.



Field 2 Setting

1. Read the barcode below to divide field 2 by a specified terminating string.



2. Read the "[Hexadecimal Value](#)" barcode on Appendix IV for the desired character string.
3. Read the "Validate" barcode on Appendix IV to complete this setting.
4. Read the "Discard Separator" barcode if the field separator is not desired in the field.

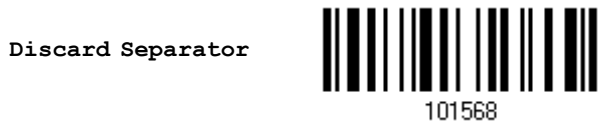

If not dividing the field by a specific separator, you may divide it by a specified length.

1. Read the barcode below to divide field 2 by length.



2. Read the "Decimal Value" barcode on Appendix IV for the desired field length.
3. Read the "Validate" barcode on Appendix IV to complete this setting.

Field 3 Setting

1. Read the barcode below to divide field 3 by a specified terminating string.



2. Read the "[Hexadecimal Value](#)" barcode on Appendix IV for the desired character string.
3. Read the "Validate" barcode on Appendix IV to complete this setting.
4. Read the "Discard Separator" barcode if the field separator is not desired in the field.



Discard Separator



101572

If not dividing the field by a specific separator, you may divide it by a specified length.

1. Read the barcode below to divide field 3 by length.

Divide Field 3
by Length



101574

2. Read the "Decimal Value" barcode on Appendix IV for the desired field length.
3. Read the "Validate" barcode on Appendix IV to complete this setting.

Field 4 Setting

1. Read the barcode below to divide field 4 by a specified terminating string.

Select
Field Separator
to Divide Field 4...



101579

2. Read the "[Hexadecimal Value](#)" barcode on Appendix IV for the desired character string.
3. Read the "Validate" barcode on Appendix IV to complete this setting.
4. Read the "Discard Separator" barcode if the field separator is not desired in the field.

*Include
Separator



101577

Discard Separator



101576

If not dividing the field by a specific separator, you may divide it by a specified length.

1. Read the barcode below to divide field 4 by length.

Divide Field 4
by Length



101578

2. Read the "Decimal Value" barcode on Appendix IV for the desired field length.
3. Read the "Validate" barcode on Appendix IV to complete this setting.



Field 5 Setting

1. Read the barcode below to divide field 5 by a specified terminating string.



2. Read the "[Hexadecimal Value](#)" barcode on Appendix IV for the desired character string.
3. Read the "Validate" barcode on Appendix IV to complete this setting.
4. Read the "Discard Separator" barcode if the field separator is not desired in the field.

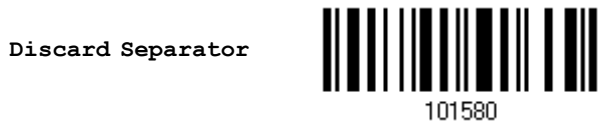

If not dividing the field by a specific separator, you may divide it by a specified length.

1. Read the barcode below to divide field 5 by length.



2. Read the "Decimal Value" barcode on Appendix IV for the desired field length.
3. Read the "Validate" barcode on Appendix IV to complete this setting.



Additional Fields

Up to five additional fields can be created for each editing format; each of them is numbered from AF1 to AF5 accordingly.

- ▶ If "BT HID" or "USB HID" is configured as interface, Key Type and Key Status will then become applicable. You may decide whether or not to apply Key Status when "Normal Key" is selected as Key Type.

Key Type		Key Status
Scan Code	Up to 2 scan code values are allowed.	N/A
Normal Key	Up to 4 character strings are allowed.	<ul style="list-style-type: none"> ▶ Add Shift ▶ Add Left Ctrl ▶ Add Left Alt ▶ Add Right Ctrl ▶ Add Right Alt Refer to 錯誤! 找不到參照來源。

1. Read the barcode below to specify an additional field, one at a time.

Additional Field 1...



Additional Field 2...



Additional Field 3...



Additional Field 4...



Additional Field 5...



2. Read the "[Hexadecimal Value](#)" barcode on Appendix IV for the desired additional field.
3. Read the "Validate" barcode on Appendix IV to complete this setting.



6.4.5 PAUSE FIELD SETTING

Pause Field Time

You can limit the pause time interval (1~16). By default, it is set to 1 second.

Pause Field Time
1~16 sec.
(*1)



1. Read the barcode above to specify the time interval for the Pause Field. (It is set to 1 by default.)
2. Read the "Decimal Value" barcode on Appendix IV. For example, read "1" and "0" for setting the Pause Field Time to 10 seconds.
3. Read the "Validate" barcode on Appendix IV to complete this setting.



6.5 CONFIGURING FORMAT — DEFINE TRANSMISSION SEQUENCE

After configuring the data fields and additional fields, you must now program the transmission sequence of these fields that comprise the final data. This field transmission sequence can be assigned in any desired order and fields can be assigned multiple times as well.

Note: Up to twelve fields can be assigned.

- 1) Read the "Start" barcode to begin with programming the field transmission sequence.



- 2) Program the transmission sequence by reading the desired fields as well as additional fields.

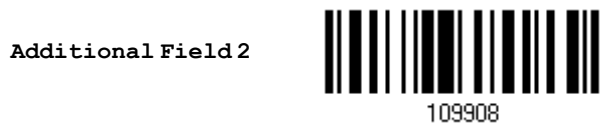
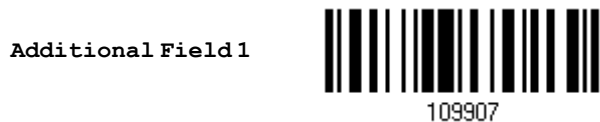

Additional Field 3



Additional Field 4



Additional Field 5



Pause Field



**Null Character
Field**



3) Read the "End" barcode to complete this setting.

End Programming...



6.6 PROGRAMMING EXAMPLES

6.6.1 EXAMPLE I

Extract data from the 10th character to the 19th character...

The editing format should be configured as follows:

1. Read the "Enter Setup" barcode to enter the Configuration Mode.
2. Read the "Configure Format 1" barcode.
3. Read the "Clear All" and "Code 128" barcodes for applicable code type.
4. Read the "Three Fields" barcode.
5. Read the "Divide Field 1 by Length" barcode, and set length to 9.
Field 1 data starts from the 1st character to the 9th character.
6. Read the "Divide Field 2 by Length" barcode, and set length to 10.
Field 2 data starts from the 10th character to the 19th character.
7. Read the "Start (Programming)" barcode to program the transmission sequence.
8. Read the "Field 2" barcode.
9. Read the "End" barcode to complete the transmission sequence setting.
10. Read the "End Programming Format" barcode to complete the setting of Editing Format 1.
11. Read the "Enable Format 1" barcode to apply Editing Format 1 to Code 128.
12. Read the "Update" barcode to exit the Configuration Mode.

6.6.2 EXAMPLE II

Extract the date code, item number, and quantity information from barcodes.

Data in a barcode is encoded like this:

- ▶ From the 1st character to the 6th character is the date code.
- ▶ From the 7th character to the dash '-' character is the item number.
- ▶ After the dash '-' character is the quantity information.

Data will be transmitted like this:

- ▶ The item number goes first, then a TAB character, followed by the date code, then another TAB character, and finally the quantity information.



The editing format should be configured as follows:

1. Read the "Enter Setup" barcode to enter the Configuration Mode.
2. Read the "Configure Format 2" barcode.
3. Read the "Three Fields" barcode.
4. Read the "Divide Field 1 by Length" barcode, and set length to 6.
Field 1 data starts from the 1st character to the 6th character.
5. Read the "Select Field Separator to Divide Field 2" barcode, and use a dash '-' character.
Field 2 data starts from the 7th character until the dash '-' character is met.
6. Read the "Additional Field 1" barcode, and use a tab character for the field.
7. Read the "Start (Programming)" barcode to program the transmission sequence.
8. Read the "Field 2", "Additional Field 1", "Field 1", "Additional Field 1", "Field 3" barcodes.
9. Read the "End" barcode to complete the transmission sequence (F2 A1 F1 A1 F3) setting.
10. Read the "End Programming Format" barcode to complete the setting of Editing Format 1.
11. Read the "Enable Format 2" barcode to apply Editing Format 2 to all code types.
12. Read the "Update" barcode to exit the Configuration Mode.



SPECIFICATIONS



Optical Characteristics	Ring Scanner	
Scan Engine	2D Imager	
Light Source	▶ SE4107 reader	Aiming LED Green LED Illumination: 1 x Warm-White LED
	▶ SE4770 reader	Aiming Red Laser (655nm) Illumination: 1 x Warm-White LED
	▶ SE5500 reader	Aiming Green Laser (520 nm) Illumination: 2x Warm white LEDs
	▶ SE4750MR reader	Aiming Red Laser (655nm) Illumination: 2x Warm white LEDs
RF Characteristics		
WPAN Module	Bluetooth 5.3 compliance(Bluetooth Low Energy)	
Coverage (line-of-sight)	Up to100 meters (Under the circumstance without any obstacles)	
Interface Supported	<ul style="list-style-type: none"> ▶ BLE SPP Lite ▶ HID Bluetooth Low Energy (HOGP) 	



Physical Characteristics		
Memory	<ul style="list-style-type: none"> ▶ 10 KB SDRAM for transmit buffer ▶ 4 MB flash for memory mode 	
Switch	Tactile switch	
Indication	Triple-color LED (Red/Green/Blue) and beeper	
Weight	Approx. 185 g	
Electrical Characteristics		
Battery	Rechargeable Li-ion battery – 3.85 V, 600 mAh	
Power Adaptor		
Input	AC 100~240 V (50/60 Hz)	
Output	DC 5V, 1A	
Operating Temperature	0 °C to 40 °C	
Environmental Characteristics		
Temperature	Operating	0 °C to 50 °C
	Storage	-40 °C to 70 °C
Humidity (Non-condensing)	Operating	10% to 90%(Non-condensing)
	Storage	5% to 95%(Non-condensing)
Resistance		
Impact Resistance	1.8 m, 5 drops per 6 sides	
Splash / Dust Resistance	IP 65	
Electrostatic Discharge	± 20 kV air discharge, ± 10 kV contact discharge	
Programming Support		
Configuration	Setup barcodes or host serial commands.	
Software	Windows®-based ScanMaster	
Firmware upgradeable	Download firmware updates via the download utility.	
Accessories (√ means “supported”)		
Rechargeable Li-ion Battery	√	
Battery Charger	√	
Bluetooth Dongle	√	
USB Cable	√	



FIRMWARE UPGRADE

You can only upgrade firmware of one scanner at a time. For example, you must turn off each of the rest scanners when there is more than one scanner connected to your computer.

Note: In case it fails downloading due to low battery, make sure the target scanner is loaded with good battery and the battery charge is enough. When the scanner tries to enter the download mode and detects low battery charge remaining, you will hear one short beep then one long beep (high-low tone) accompanied by the LED indicator flashing five times. Then the upgrade task is aborted.

HOW TO UPGRADE SCANNER FIRMWARE

USING USB-TYPE C CABLE

- 1) Connect USB Type-C cable between the USB port of the ring scanner and your computer. (Only Windows 10 or above are supported.)
- 2) In case the OS run in the host computer is Windows, please have your ring scanner read the following barcodes in sequence to configure its interface as USB VCOM_CDC.

Enter Setup



Activate
Direct USB
VCOM_CDC



100010

Update



109999

- 3) Read the following barcodes in sequence for the scanner to enter the download mode. The scanner will respond with beeps to indicate it is ready for the downloading.

Enter Setup



Download



109997

- 4) Run the download utility "ProgLoad.exe" on your computer.



User Program
STD_RingScanner_V*.shx

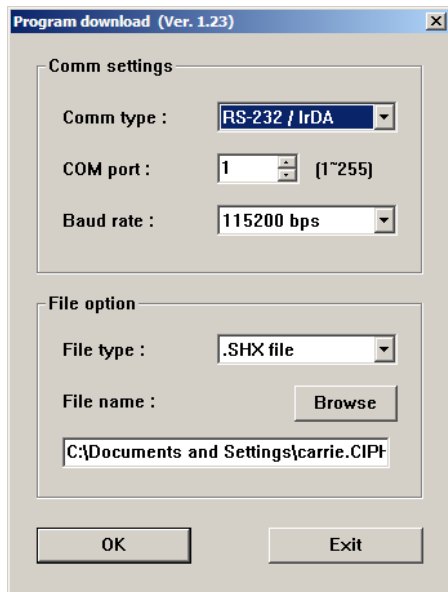

- ▶ For the communication settings, select "RS-232/IrDA" and the correct COM port for RS-232 or USB Virtual COM interface.
- ▶ For RS-232, select 115200 bps for baud rate
- ▶ For the file option, click [Browse] to select the target file for firmware update after selecting .SHX file as the file type.
- ▶ Click [OK].

Note: After the firmware is transmitted to the ring scanner, LED will flash in red and green colors by turns to indicate that the firmware is upgrading. Wait for 40 seconds around and do not power off the device by removing the battery or pressing the **Shutdown Key** during the process of the firmware upgrade. The scanner will automatically restart when the upgrade is completed.

CONNECT TO CIPHERLAB MOBILE COMPUTER VIA BLUETOOTH

To do the firmware upgrade for the ring scanner through the bluetooth connection, make sure the bluetooth connection between the mobile computer and the scanner has been established beforehand. You may refer to [Chapter 3 – Setting up a WPAN Connection](#) for more details with regard to the ways of building this connection. And follow the procedures listed below step by step, the firmware can be updated easily.

- 1) Launch **CipherLab Intelliworker** App installed on your mobile computer.
- 2) Rename the new firmware file to be upgraded as ring_scanner.shx.
- 3) Create a new directory of Android\data\sw.programme.intelliworker\files\Download on the mobile computer. Then, place the file of ring_scanner.shx you rename in Step 2 under this directory.
- 4) Tap **more** button at the top-right corner of the main screen, and then tap **Update Firmware** function from the menu displayed to proceed the upgrade.

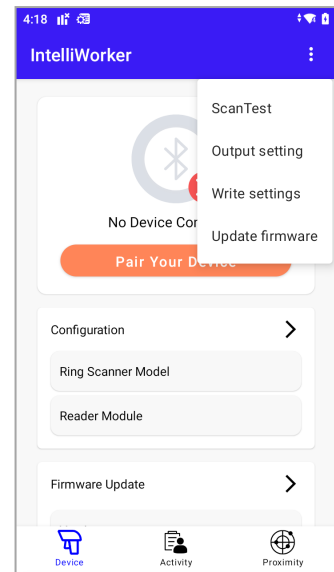

HOST SERIAL COMMANDS

SERIAL COMMANDS

D

Purpose To disable the scanner.
Remarks "D"

E

Purpose To enable the scanner.
Remarks "E"

#@ nnnnnn <CR>

Purpose To configure the scanner.
Remarks nnnnnn – the six digits of command parameters.
For example, "109952" is to list the current Code ID settings.

List Page 3



109952

Serial Command

←

"0x23" + "0x40" + "0x31" + "0x30" + "0x39" + "0x39" + "0x35" + "0x32" + "0x0d"

Note: After configuring the scanner, you may send the serial command "#@109999" to save the settings.

#@ ----<CR>

Purpose To halt the scanner.
Remarks "0x23" + "0x40" + "0x2d" + "0x2d" + "0x2d" + "0x2d" + "0x0d"

#@<CR>

Purpose To resume operation.
Remarks "0x23" + "0x40" + "0x2e" + "0x2e" + "0x2e" + "0x2e" + "0x0d"

#@////<CR>

Purpose To respond with a beep.
Remarks "0x23" + "0x40" + "0x2f" + "0x2f" + "0x2f" + "0x2f" + "0x0d"



#@TRIGOFF<CR>

Purpose	To disable the software trigger
Remarks	"0x23" + "0x40" + "0x54" + "0x52" + "0x49" + "0x47" + "0x4f" + "0x46" + "0x46" + "0x0d"

#@TRIGON<CR>

Purpose	To enable the software trigger
Remarks	"0x23" + "0x40" + "0x54" + "0x52" + "0x49" + "0x47" + "0x4f" + "0x4e" + "0x0d"

#@RDSN<CR>

Purpose	Read serial number
Remarks	"0x23" + "0x40" + "0x52" + "0x44" + "0x53" + "0x4E" + "0x0D"

#@BEEP, nn<CR>

Purpose	Have the scanner beep as many times as you specified ranging from 00 to 99 times (00 is to stop the work). The length of beep time is based on the duration of Good Read Beep setting and the constant interval between two beeps is 100ms.
Remarks	nn – the two digits of command parameters For example, '#@BEEP,09' is to have the scanner beep for 9 times. "0x23" + "0x40" + "0x42" + "0x45" + "0x45" + "0x50" + "0x2c" + "0x30" + "0x39" + "0x0d"

#@RLED, nn<CR>

Purpose	Have the scanner's red LED indicator blink as many times as you specified ranging from 00 to 99 (00 is to stop the work). The length of blinking time is based on the Good Read LED Duration setting and the constant interval between two flashes is 200ms.
Remarks	nn –the two digits of command parameters For example, '#@RLED,09' is to have the scanner blink for 9 times. "0x23" + "0x40" + "0x52" + "0x4c" + "0x45" + "0x44" + "0x2c" + "0x30" + "0x39" + "0x0d"

#@GLED, nn<CR>

Purpose	Have the scanner's green LED indicator blink as many times as you specified ranging from 00 to 99 (00 is to stop the work). The length of blinking time is based on the Good Read LED Duration setting and the constant interval between two flashes is 200ms.
---------	--



Remarks nn – the two digits of command parameters
For example, `#@GLED,09` is to have the scanner blink for 9 times.
"0x23" + "0x40" + "0x47" + "0x4c" + "0x45" + "0x44" + "0x2c" + "0x30"
+ "0x39" + "0x0d"



EXAMPLE

You may run **HyperTerminal.exe** on the host computer to send serial commands to the ring scanner via USB VCOM CDC.

- ▶ For the scanner to stop immediately –

D

- ▶ For the scanner to resume working –

E

- ▶ For the scanner to change the beeper to medium volume and beep –

#@101011<CR>

#@////<CR>

- ▶ For the scanner to change the beeper to minimal volume and beep –

#@101010<CR>

#@////<CR>

- ▶ For the scanner to change the beeper frequency to 8 kHz (for Good Read Beep only) and beep –

#@101001<CR>

#@////<CR>

- ▶ For the scanner to change the beeper length to longest (for Good Read Beep only) and beep –

#@101008<CR>

#@////<CR>

- ▶ For the scanner to save the settings, send the serial command “#@109999” –

#@101011<CR>

#@109999<CR>

- ▶ For the scanner to read the serial number and beep –

#@RDSN<CR>

#@////<CR>

- ▶ For the scanner to beep for nine times –

#@BEEP,09<CR>

- ▶ For the scanner's LED indicator to blink in red for nine times –

#@RLED,09<CR>

- ▶ For the scanner's LED indicator to blink in green for nine times –

#@GLED,09<CR>



WR30 USB DONGLE SETUP BARCODES & SERIAL COMMANDS

Normally, you can configure WR30 Dongle by having one of the connected scanners read the related setup barcodes.

- 1) Connect WR30 Dongle to your computer. (WR30 Dongle only supports Windows 10 operating system or above.)
- 2) Refer to [Section 3.5.1 Connect to WR30 Dongle](#) for the target scanner to connect to WR30 Dongle.
- 3) Have the ring scanner read the following barcodes in sequence to configure WR30 Dongle.

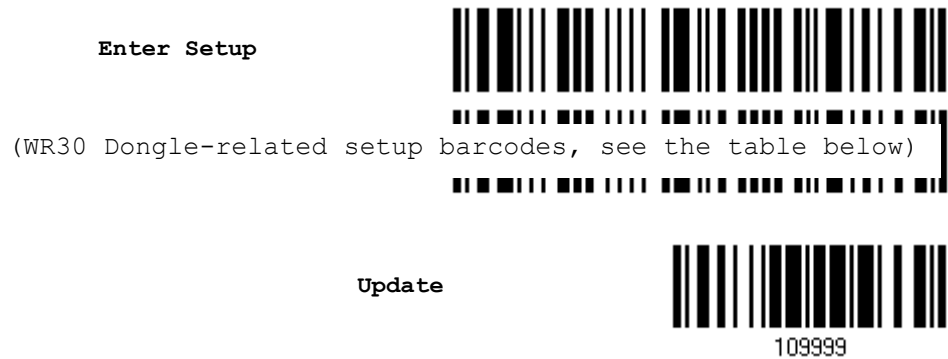

For WR30 Dongle-related setup barcodes, refer to the Serial Command table below. Note that for the "Version" and "GetID" barcodes, you must run HyperTerminal.exe or any text editor on your computer to receive the information replying from WR30 Dongle.

- ▶ If the output interface is USB Virtual COM CDC, run HyperTerminal.exe on your computer to receive the information replying from WR30 Dongle.
- ▶ If the output interface is USB HID, run Notepad.exe on your computer to receive the information replying from WR30 Dongle.



WR30 USB DONGLE SERIAL COMMAND AND EQUIVALENT SETUP BARCODES

Config<CR>

Purpose To configure WR30 Dongle.

Here is the setup barcode for this serial command:



Remarks A list of the current settings will be displayed. Run HyperTerminal.exe on your computer and change the settings one by one.

DefaultSetting<CR>

Purpose To restore the default settings.

Here is the setup barcode for this serial command:



Version<CR>

Purpose To get the current firmware version of WR30 Dongle.

Here is the setup barcode for this serial command:



GetID<CR>

Purpose To get MAC ID of WR30 Dongle.

Here is the setup barcode for this serial command:



Download<CR>

Purpose To download CPU firmware to WR30 Dongle (via USB VCOM CDC).

Here is the setup barcode for this serial command:



EXAMPLE

Without using the scanner to read the above setup barcodes for configuring WR30 Dongle, you may run HyperTerminal.exe on the host computer to send the above serial commands to WR30 Dongle.

- 1) Connect WR30 Dongle to your computer.(WR30 Dongle only supports Windows 10 operating system or above.)

The LED of WR30 Dongle will indicate when WR30 Dongle can accept the serial commands from the computer after initializing. Refer to the table below.

- ▶ If the output interface is USB Virtual COM CDC, run HyperTerminal.exe on your computer. While the LED on WR30 Dongle starts flashing in blue color, type the serial command within three seconds.
- ▶ If the output interface is USB HID, press the "Num Lock" or "Caps Lock" key on your keyboard 5 times within 3 seconds while the LED on WR30 Dongle is flashing blue until the third time. This will change the interface from USB HID to USB Virtual COM CDC. Then, run HyperTerminal.exe on your computer to ensure that the corresponding COM Port No. is connected. Type the serial command within three seconds. After configuring via the serial commands, the interface will be reset to USB HID after re-plugging in WR30 Dongle.

WR30 Dongle LED		Meaning
	Blue, flashing	The LED slowly flashes in blue color (On/Off ratio 0.5 s: 0.5 s) to indicate that WR30 Dongle is waiting for the bluetooth connection.
	Blue, flashing	The LED rapidly flashes in blue color (On/Off ratio 0.1 s: 0.1 s) to indicate that the connection between WR30 Dongle and the ring scanner via bluetooth is established.
	Blue, solid	The firmware upgrade of WR30 Dongle is in progress.



KEYBOARD WEDGE TABLE

APPLY SPECIAL KEYBOARD

The table below features special keyboard wedge codes applied to the scanner by default. If you have determined to bypass this special keyboard, please refer to the table on the next page.

"Apply" Special Keyboard									
	0	1	2	3	4	5	6	7	8
0		F2	SP	0	@	P	`	p	⓪
1	INS	F3	!	1	A	Q	a	q	①
2	DLT	F4	"	2	B	R	b	r	②
3	Home	F5	#	3	C	S	c	s	③
4	End	F6	\$	4	D	T	d	t	④
5	Up	F7	%	5	E	U	e	u	⑤
6	Down	F8	&	6	F	V	f	v	⑥
7	Left	F9	'	7	G	W	g	w	⑦
8	BS	F10	(8	H	X	h	x	⑧
9	HT	F11)	9	I	Y	i	y	⑨
A	LF	F12	*	:	J	Z	j	z	
B	Right	ESC	+	;	K	[k	{	
C	PgUp	Exec	,	<	L	\	l		
D	CR	CR*	-	=	M]	m	}	
E	PgDn		.	>	N	^	n	~	
F	F1		/	?	O	_	o	Dly	ENTER*

Note: (1) ①~⑨: Digits of numeric keypad.
 (2) CR*/ENTER*: ENTER key on the numeric keypad.



BYPASS SPECIAL KEYBOARD

"Bypass" Special Keyboard									
	0	1	2	3	4	5	6	7	8
0			SP	0	@	P	`	p	
1			!	1	A	Q	a	q	
2			"	2	B	R	b	r	
3			#	3	C	S	c	s	
4			\$	4	D	T	d	t	
5			%	5	E	U	e	u	
6			&	6	F	V	f	v	
7			'	7	G	W	g	w	
8	BS		(8	H	X	h	x	
9	HT)	9	I	Y	i	y	
A	LF		*	:	J	Z	j	z	
B		ESC	+	;	K	[k	{	
C			,	<	L	\	l		
D	CR		-	=	M]	m	}	
E			.	>	N	^	n	~	
F			/	?	O	_	o	Dly	



BYPASS SPECIAL KEYBOARD WITH CONTROL CHARACTER OUTPUT

"Bypass" Special Keyboard with Control Character Output									
	0	1	2	3	4	5	6	7	8
0		DLE	SP	0	@	P	`	p	
1	SOH	DC1	!	1	A	Q	a	q	
2	STX	DC2	"	2	B	R	b	r	
3	ETX	DC3	#	3	C	S	c	s	
4	EOT	DC4	\$	4	D	T	d	t	
5	ENQ	NAK	%	5	E	U	e	u	
6	ACK	SYN	&	6	F	V	f	v	
7	BEL	ETB	'	7	G	W	g	w	
8	BS	CAN	(8	H	X	h	x	
9	HT	EM)	9	I	Y	i	y	
A	LF	SUB	*	:	J	Z	j	z	
B	VT	ESC	+	;	K	[k	{	
C	FF	FS	,	<	L	\	l		
D	CR	GS	-	=	M]	m	}	
E	SO	RS	.	>	N	^	n	~	
F	SI	US	/	?	O	_	o	Dly	

Note: When Special Keyboard is set to "Bypass with Control Character Output" (refer to [Section 2.1.7 Special Keyboard Feature](#)), the control characters ranging from 0x01 to 0x1F (SOH ~ US) can then be sent to host computer (Windows only).



KEY TYPE & STATUS

KEY TYPE

If "BT HID" or "USB HID" is configured as interface, Key Type and Key Status will then become applicable.

*Normal



Scan Code



KEY STATUS

Decide whether or not to change key status when "Normal Key" is selected as Key Type.

Add Shift



Add Left Ctrl



Add Right Ctrl



Add Left Alt



Add Right Alt



EXAMPLE

Key Type = Normal

For example, if you want to program the character “!” as the prefix code:

1. Read the “Configure Prefix” barcode.
2. Read the “[Hexadecimal Value](#)” barcode on Appendix IV for “2” and “1”.
3. Read the “Validate” barcode on Appendix IV to complete this setting.

Key Type = Scan Code

For example, if you want to program the character “a” (= “1C” on the scan code table) as the prefix code:

1. Read the “Configure Prefix” barcode.
2. Read the “Scan Code” barcode.
3. Read the “[Hexadecimal Value](#)” barcode on Appendix IV for “1” and “C”.
4. Read the “Validate” barcode on Appendix IV to complete this setting.

Key Type = Normal + Key Status = Shift

For example, if you want to program the character “!” (= “Shift” + “1” on keyboard) as the prefix code:

1. Read the “Configure Prefix” barcode.
2. Read the “Add Shift” barcode.
3. Read the “[Hexadecimal Value](#)” barcode on Appendix IV for “3” and “1”.
4. Read the “Validate” barcode on Appendix IV to complete this setting.

Key Type = Normal + Key Status = Ctrl

For example, if you want to program “Ctrl+A” and “Ctrl+\$” as the prefix code:

1. Read the “Configure Prefix” barcode.
2. Read the “Add Left Ctrl” barcode.
3. Read the “[Hexadecimal Value](#)” barcode on Appendix IV for “4”, “1” (= “A”).
4. Read the “Add Left Ctrl” barcode.
5. Read the “[Hexadecimal Value](#)” barcode on Appendix IV for “2”, “4” (= “\$”).
6. Read the “Validate” barcode on Appendix IV to complete this setting.



NUMERAL SYSTEMS

DECIMAL SYSTEM

Decimal



Validate the Values



Validate

Update



Abort



HEXADECIMAL SYSTEM

Hexadecimal



Validate the Values



Validate



Enter Setup

ASCII TABLE

	0	1	2	3	4	5	6	7	
0		DLE	SP	0	@	P	`	p	
1	SOH	DC1	!	1	A	Q	a	q	
2	STX	DC2	"	2	B	R	b	r	
3	ETX	DC3	#	3	C	S	c	s	
4	EOT	DC4	\$	4	D	T	d	t	
5	ENQ	NAK	%	5	E	U	e	u	
6	ACK	SYN	&	6	F	V	f	v	
7	BEL	ETB	'	7	G	W	g	w	
8	BS	CAN	(8	H	X	h	x	
9	HT	EM)	9	I	Y	i	y	
A	LF	SUB	*	:	J	Z	j	z	
B	VT	ESC	+	;	K	[k	{	
C	FF	FS	,	<	L	\	l		
D	CR	GS	-	=	M]	m	}	
E	SO	RS	.	>	N	^	n	~	
F	SI	US	/	?	O	_	o	DEL	

Update



Abort



READING DRIVER LICENSES

The scanner is capable of reading 2D driver's licenses and other American Association of Motor Vehicle Administrators (AAMVA) compliant ID cards. For compliant 2D licensed card scanning, it decodes the information embedded in the ID cards to a formatted data. This appendix provides the setup barcodes required while ScanMaster utility provides GUI setup that is organized and easy-to-use.

Note: The configured settings are saved in flash memory for access once a driver's license is read.

LICENSE PARSING SETUP

***License Parse Disable**



103000

License Parse Enable



103001

Parse Field Clear



103002

FILE TYPE

You can check the file type of ANSI by scanning the barcode as below.

***Enable**



103004

Disable













103003



OUTPUT SEQUENCE SETUP

The scanner supports arranging the sequences of license embedded data via separators and fields. In order to present data in a consistent format, some barcodes (ex. First Name, Middle Name/Initial, Last Name, Name suffix, Name Prefix, Birth Date and so on) will return data based on the calculated actual data contained in the ID barcode.













Full Name	 103011
Last Name	 103012
First Name	 103013
Middle Name/Initial	 103014
Name Suffix	 103015
Name Prefix	 103016
Mailing Address Line1	 103017
Mailing Address Line2	 103018
Mailing Address City	 103019
Mailing Address State	 103020

Update















Abort



Mailing Address Postal Code	 103021
Home Address Line1	 103022
Home Address Line2	 103023
Home Address City	 103024
Home Address State	 103025
Home Address Postal Code	 103026
License ID Number	 103027
License Class	 103028
License Restrictions	 103029
License Endorsements	 103030
Height (Feet and/or Inches)	 103031
Height (Centimeters)	 103032















Weight (Pounds)	
	103033
Weight (Kilograms)	
	103034
Eye Color	
	103035
Hair Color	
	103036
License Expiration Date	
	103037
Birth Date	
	103038
Gender	
	103039
License Issue Date	
	103040
Issue Timestamp	
	103041
Number of Duplicates	
	103042
Medical Codes	
	103043
Organ Donor	
	103044

Update

Abort

Nonresident	 103045
Customer ID	 103046
Social Security Number	 103047
AKA Birth Date	 103048
AKA Social Security Name	 103049
AKA Full Name	 103050
AKA Last Name	 103051
AKA First Name	 103052
AKA Middle Name/Initial	 103053
AKA Name Suffix	 103054
AKA Name Prefix	 103055
Weight Range	 103056













Document Discriminator	 103057
Country	 103058
Federal Commission Codes	 103059
Place of Birth	 103060
Audit Information	 103061
Inventory Control	 103062
Race/Ethnicity	 103063
Std Vehicle Class	 103064
Std Restrictions	 103065
Std Endorsements	 103066
Class Description	 103067
Endorsement Description	 103068

Update



Abort













Restrictions Description	 103069
Permit Class	 103070
Permit Expiration Date	 103071
Permit ID Number	 103072
Permit Issue Date	 103073
Permit Restrictions	 103074
Permit endorsements	 103075
Issuer ID Number	 103076
Family Name Truncation	 103077
First Name Truncation	 103078
Middle Name Truncation	 103079



SEPARATORS AND FIELDS

Define the separators that separate fields during the transmission sequence of data scanning. In addition to the built-in data elements, you can also specify up to 5 Additional Fields with 4 bytes characters. Program the transmission sequence by reading the desired fields as additional fields.

Note: Up to 5 separators can be assigned.

Separator 1 (1 byte) *"Space"	 103128
Separator 2 (1 byte) *"Enter"	 103129
Separator 3 (1 byte) *" ,"	 103130
Separator 4 (1 byte) *" ."	 103131
Separator 5 (1 byte) *" -"	 103132
Additional Field 1 (4 bytes)	 103133
Additional Field 2 (4 bytes)	 103134
Additional Field 3 (4 bytes)	 103135
Additional Field 4 (4 bytes)	 103136
Additional Field 5 (4 bytes)	 103137

Update



Abort



EDIT SEPARATORS

All the driver license fields can be split with a pre-selected separator, for example, "-" as First Name-Last Name or ":" as First Name:Last Name.

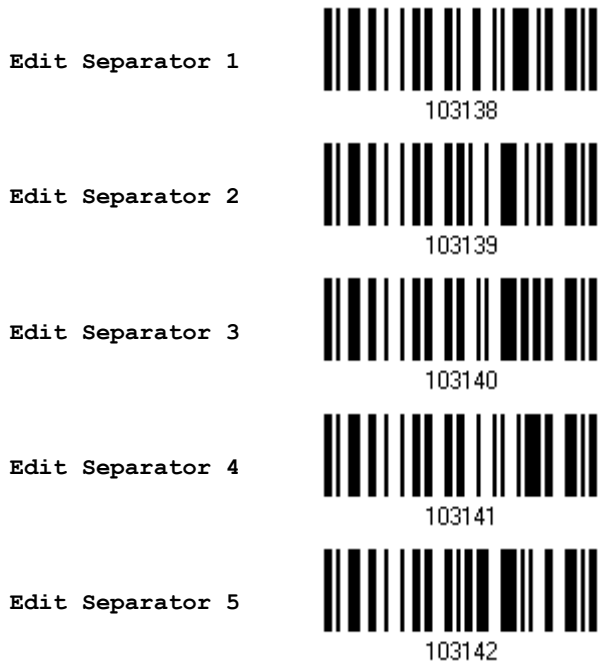

- 1) Read the barcode above to apply separator to driver license information separately, and follow steps 2~3.
- 2) Read the "[Hexadecimal Value](#)" barcode on Appendix IV for the desired character string. For example, read "3" and "A" for the separator to split the data with character [:].
- 3) Read the "Validate" barcode on Appendix IV to complete this setting.



EDIT FIELDS

Up to five additional fields can be created for each editing format; each of them is numbered from Additional 1 to Additional 5 accordingly.

- ▶ If "Bluetooth® HID" or "USB HID" is configured for interface, Key Type and Key Status will then become applicable. You may decide whether or not to apply Key Status when "Normal Key" is selected for Key Type.

Key Type		Key Status
Scan Code	Up to 2 scan code values are allowed.	N/A
Normal Key	Up to 4 character strings are allowed.	<ul style="list-style-type: none"> ▶ Add Shift ▶ Add Left Ctrl ▶ Add Left Alt ▶ Add Right Ctrl ▶ Add Right Alt Refer to Appendix III Keyboard Wedge Table .

Edit Additional Field 1



103143

Edit Additional Field 2



103144

Edit Additional Field 3



103145

Edit Additional Field 4



103146

Edit Additional Field 5



103147

- 1) Read the barcode above to specify an additional field, one at a time.
- 2) Read the "Hexadecimal Value" barcode for the desired additional field.
- 3) Read the "Validate" barcode on the same page to complete this setting.

Update



Abort



KEYBOARD TYPE ONE-SCAN BARCODE

BLUETOOTH HID

PCAT (US)



PCAT (French)



PCAT (German)



PCAT (Italian)



PCAT (Swedish)



PCAT (Norwegian)



PCAT (UK)



PCAT (Belgium)



PCAT (Spanish)



PCAT (Portuguese)



PS55 A01-2 (Japanese)



User-defined table



PCAT (Turkish)



PCAT (Hungarian)



PCAT (Swiss German)



PCAT (Danish)



PCAT (Greek)



PCAT (Russian)



PCAT (Cyrillic on Russian)



PCAT (Armenian)



PCAT (Thai)



PCAT (Slovenian)



PCAT (Mexican Spanish)



PCAT (Swiss French)



PCAT (Czech)



DIRECT USB HID

PCAT (US)



PCAT (French)



PCAT (German)



PCAT (Italian)



PCAT (Swedish)



PCAT (Norwegian)



PCAT (UK)



PCAT (Belgium)



PCAT (Spanish)



PCAT (Portuguese)



PS55 A01-2 (Japanese)



User-defined table



PCAT (Turkish)



PCAT (Hungarian)



PCAT (Switzerland German)



PCAT (Danish)



PCAT (Greek)



PCAT (Russian)



PCAT (Armenian)



PCAT (Cyrillic on Russian)



PCAT (Thai)



PCAT (Slovenian)



PCAT (Mexican Spanish)



PCAT (Swiss French)



PCAT (Czech)



REMOTE USB HID (WR30 DONGLE)

PCAT (French)



PCAT (Italian)



PCAT (Norwegian)



PCAT (Belgium)



PCAT (US)



PCAT (German)



PCAT (Swedish)



PCAT (UK)



PCAT (Spanish)



PCAT (Portuguese)



PS55 A01-2 (Japanese)



User-defined table



PCAT (Turkish)



PCAT (Hungarian)



PCAT (Swiss German)



PCAT (Danish)



PCAT (Greek)



PCAT (Russian)



PCAT (Cyrillic on Russian)



PCAT (Armenian)



PCAT (Thai)



PCAT (Slovenian)



PCAT (Mexican Spanish)



PCAT (Swiss French)



PCAT (Czech)

